



Montageanleitung

Mounting instruction

H0 LIEBHERR Teleskop-Autokran LTM 1160/2

H0 LIEBHERR mobile telescopic crane LTM 1160/2

(DE)

1. Wichtige Hinweise	1
2. Inhalt	2
3. Montage	4

(EN)

1. Important information	1
2. Contents	2
3. Mounting	4

Die aktuelle Version der Anleitung finden Sie auf der Kibri-Homepage unter der Artikelnummer.

You will find the latest version of the manual on the kibri website using the item-No.

Änderungen vorbehalten. Keine Haftung für Druckfehler und Irrtümer.

Subject to change without prior notice. No liability for mistakes and printing errors.



Viessmann Modelletechnik GmbH
Bahnhofstraße 2a
D - 35116 Hatzefeld-Reddighausen
info@viessmann-modell.com
+49 6452 9340-0
www.viessmann-modell.de

**Schwierigkeitsgrad
der Bausätze:**
Level of difficulty:

Made in Europe



86014
Stand 03/sw
08/2021
Szt

(DE)

1. Wichtige Hinweise

Bitte halten Sie beim Zusammenbau unbedingt die Reihenfolge der Bauabschnitte ein!

Sicherheitshinweise

 **Vorsicht**

Verletzungsgefahr!

Aufgrund der detaillierten Abbildung des Originals bzw. der vorgesehenen Verwendung kann das Produkt Spitzen, Kanten und abbruchgefährdete Teile aufweisen. Für die Montage sind Werkzeuge nötig.

Montage des Bausatzes

Die beim jeweiligen Montageschritt benötigten Teile trennen Sie bitte mit einem Seitenschneider bzw. Modellbaumesser vorsichtig vom Spritzbaum ab und entgraten die Ränder.

Da Spritzlinge für mehrere Artikel verwendet werden, kann es sein, dass bei diesem Bausatz einige Teile übrig bleiben.

Dieser Bausatz wurde sorgfältig geprüft und verpackt. Sollte es trotzdem einmal vorkommen, dass ein Teil fehlt, fordern Sie dieses bitte per E-Mail oder per Post bei uns an. Bitte nennen Sie uns die Bezeichnung und Artikel-Nummer des Bausatzes sowie Spritzling- und Teile-Nr. Diese Angaben finden Sie in der Montageanleitung. Sie erhalten dann umgehend von uns Ersatz.

Passenden Kleber für die Bausätze finden Sie im Kibri Sortiment.

(EN)

1. Important information

Please observe the correct sequence when assembling the parts to sub-assemblies and to the completed product!

Safety information

 **Caution:**

Risk of injury!

Due to the finely detailed reproduction of the original and the intended use, this product may have sharp points or edges as well as parts that may easily break off. Some tools are required for assembly.

Assembly

Carefully separate the parts required for the respective assembly phase with a side cutter or a sharp utility knife from the injection-moulded sprue and deflash the edges.

Since some sprues are used for several different products it is quite possible that some parts may not be needed for this particular product.

The contents of this kit have been carefully checked against the parts list. However, should a part be missing please contact us by e-mail or by sending a letter. Please state the precise product description and the item-No. as well as the No. of the sprue and the specific part that is missing. You will find all necessary information in this manual. We will promptly supply the missing parts.

You will find suitable glue for the kits in the Kibri product range.

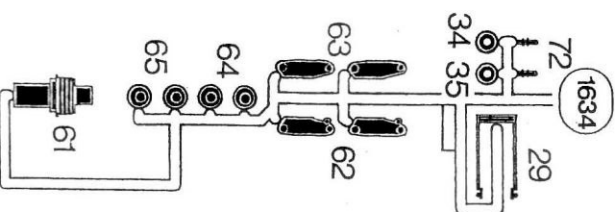
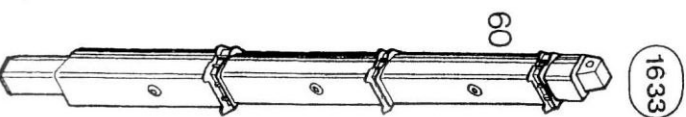
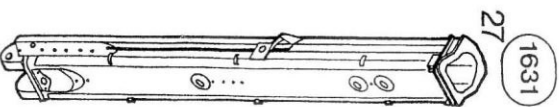
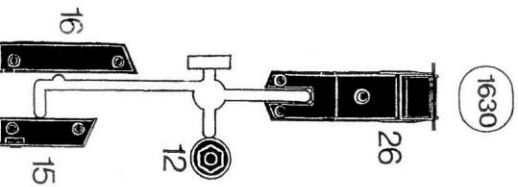
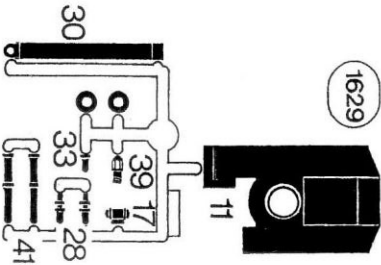
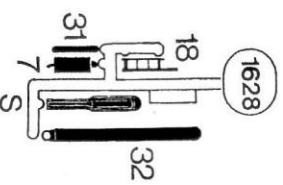
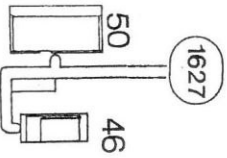
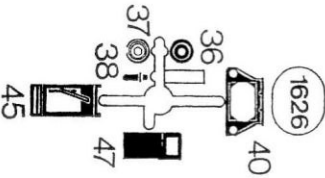
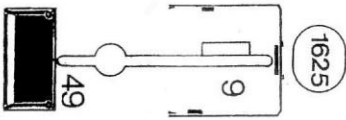
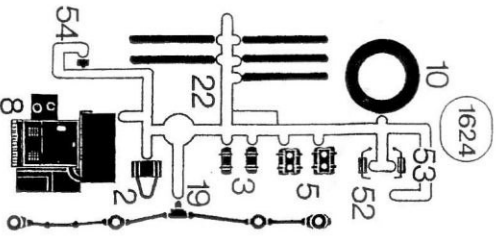
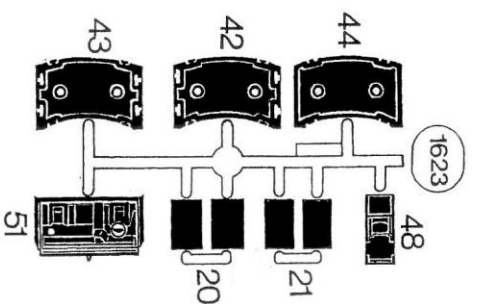
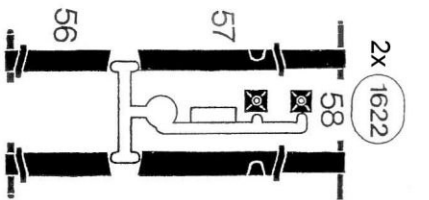
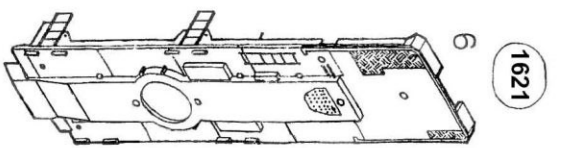
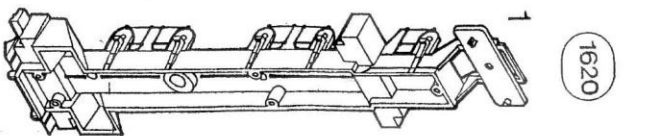
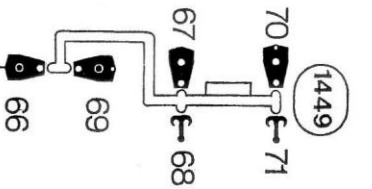
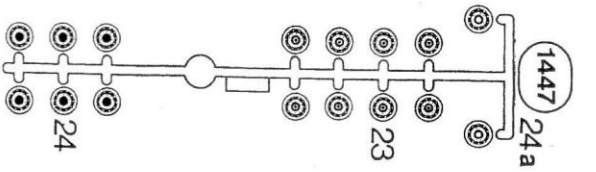
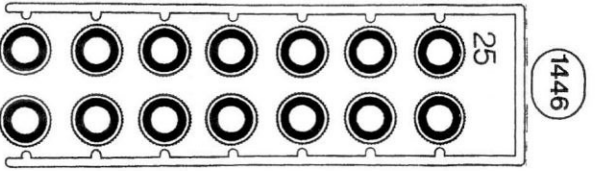
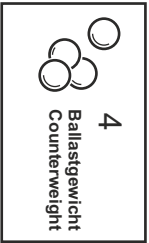
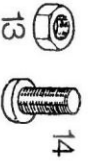
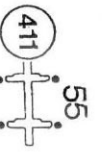

3. Montage Mounting

1

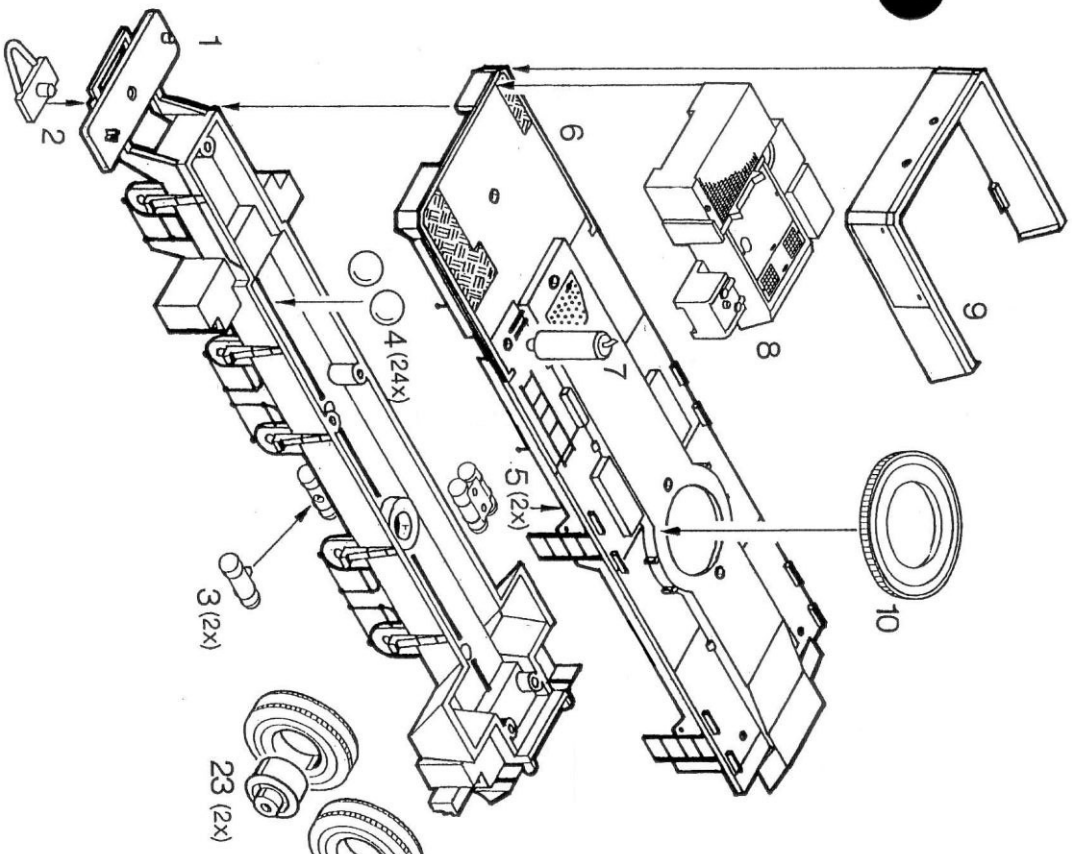

2

