

45758

H0 Ringlokschuppen mit Türschließvorrichtung, sechsständig

H0 Roundhouse with door lock mechanism, six track

(DE)

Bitte bauen Sie das Modell gemäß den einzelnen Montageschritten zusammen.

1. Inhalt 1
2. Montage 2

(EN)

Please assemble the model according to the individual assembly steps.

1. Contents 1
2. Mounting 2

1. Inhalt / Contents

Dekopapier / Decoration sheet: 135557

Zugstange / Drawbar: 138646 6

Türschließfeder / Door closing spring: 138066 6

Farbtablette / Colour tablet: 138502 1

Spritzlingsnr.	Teile-Nr.	Stück	Spritzlingsnr.	Teile-Nr.	Stück	Spritzlingsnr.	Teile-Nr.	Stück	Spritzlingsnr.	Teile-Nr.	Stück	Spritzlingsnr.	Teile-Nr.	Stück
Sprue No.	Part No.	Pieces	Sprue No.	Part No.	Pieces	Sprue No.	Part No.	Pieces	Sprue No.	Part No.	Pieces	Sprue No.	Part No.	Pieces
10784	2	1	11087	23	1	11120	8	6	19159	19120	1	25763	25754	1
	2a	1					81	4		19121	3		25755	1
	2b	1	11088	24	1					19122	1		25756	1
	2c	1		25	1	11137	19173	1		19123	1		25757	1
	19201	1		26	1		19174	6		19124	1		25758	1
				27	1		19175	6		19125	1		25759	1
10709	0011	2		28	1		19176	6		19126	1		25760	1
	0012	2					19177	6		19127	1		25761	1
	0106	2	12292	29	1		19178	1		19128	1		25762	1
				30	1		19179	8		19129	1		54771	1
							19180	1		19156	1			
10722	31	1	11044	1	2		19181	1		19157	1	57630	57626	6
	32	1		2	2		19182	8		20971	1		57627	6
	33	1		3	2		20972	1					57628	6
	34	1		4	3		20973	1	19598	19107	6		57629	6
	19117	1					20974	1		19108	2			
							20975	1		19109	5			
10732	0223	1	11122	4	6									
				5	4									
11024	2	4	11123	14	2	11139	0273	6	19164	19160	4			
	3	2		15	2		0274	6		19161	1			
										19162	6			
11028	11	6				11027	19090	6		19163	6			
	12	6	11124	11124	6		19091	6						
							15827	6	20962	11079	10			
11026	6	4	11126	0024	6		15828	6		20956	1			
	7	4		0018	6					20957	1			
	19089	4		0272	12	11121	1	6		20958	1			
										20959	1			
11080	11080	2	11128	20	2	11127	019	6		20960	1			
				21	2		021	6		20961	1			
11032	0023	16		22	2									
	0023/1	4		0264	1	11125	16	6	20967	20963	1			
							17	6		20964	1			
11037	11037	1	11129	0246	12		18	6		20965	1			
							19	6		20966	1			
11035	11035	6	11135	11135	1									
11095	0263	14	11136	11136	2	10824	10824	36						
11036	0017	12	11083	0265	6									

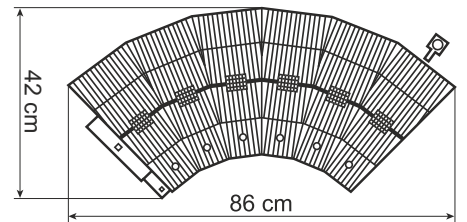

(DE)

Dieser Bausatz besteht aus dem recyclefähigen Kunststoff Polystyrol.

(EN)

This kit consists of recyclable polystyrene.



2. Montage / Mounting

1 6x

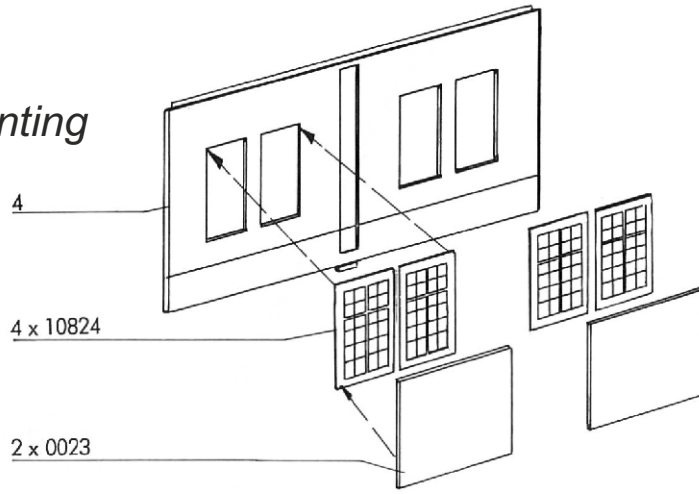

Aufbauvariante 1 Alternative construction 1

2 6x

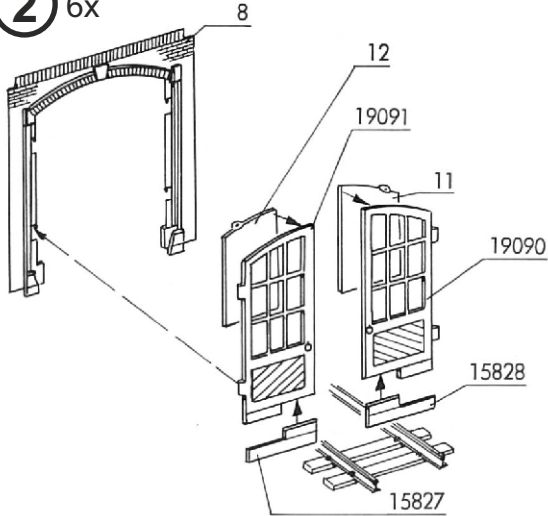

Für Modellgleise. For model tracks.

Märklin-K, Fleischmann Modell Gleis, Roco LINE, Hornby, Piko A-Gleis, Tillig Standard, Tillig Elite, Bemo Standard Gleis, Bemo C70, Mehano Hobby Gleis, Peco Setrack, Peco Streamline, Peco Streamline 83, Peco Finescale, Kato Unitrack, Shinohara Code 70, Shinohara Code 83, JHM STS.

Aufbauvariante 2 Alternative construction 2

Für Bettungsgleise. For road bed track.

Märklin C-Gleis, Kato Unitrack H0, Roco LINE, Roco geoLINE, Tillig Elite H0, Trix C-Gleis, Peco Finescale H0, Fleischmann Profi-Gleis, Bemo Standard Gleis, Bemo C70 Schmalspur.

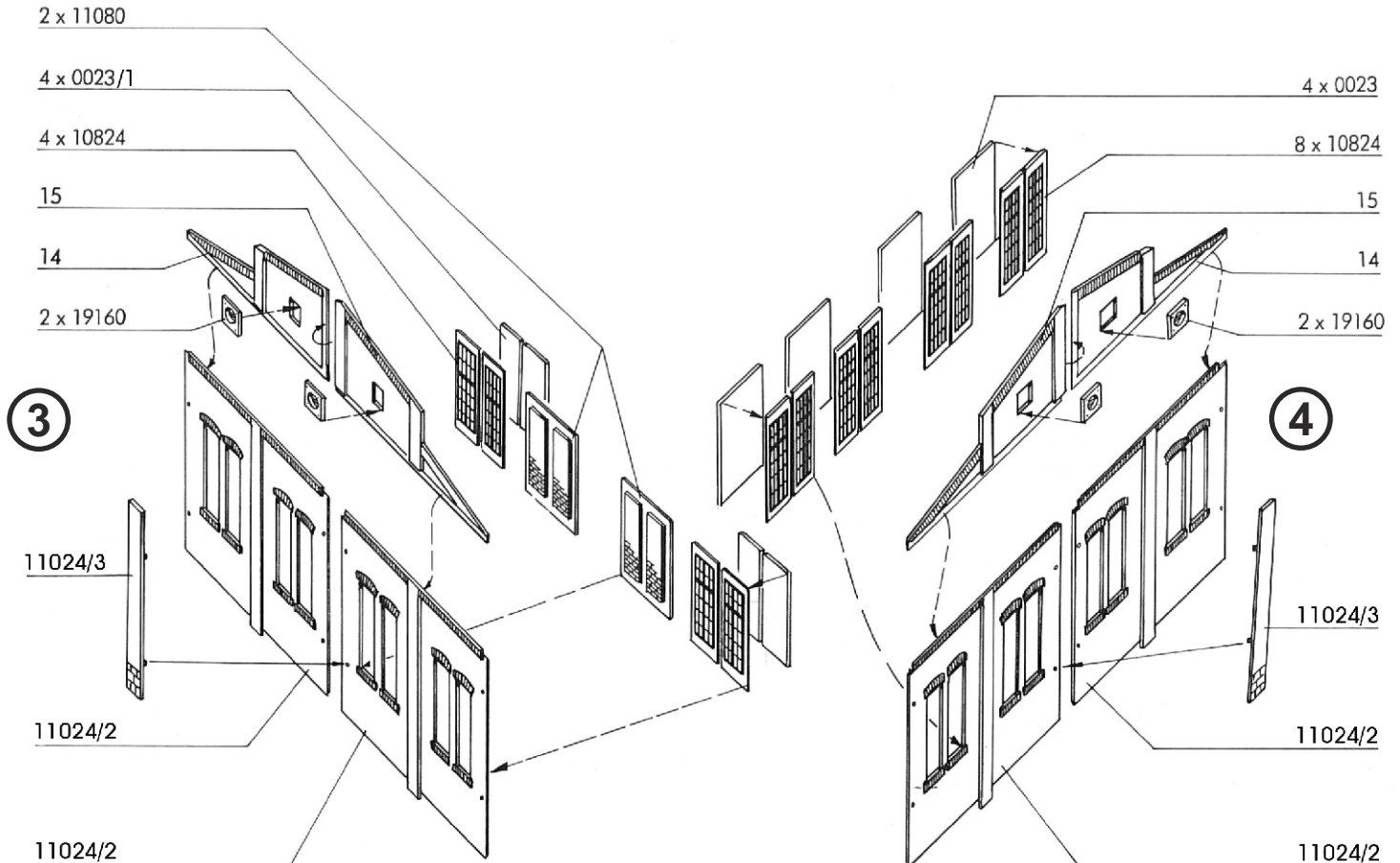
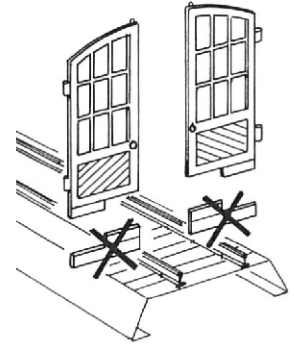

3

4

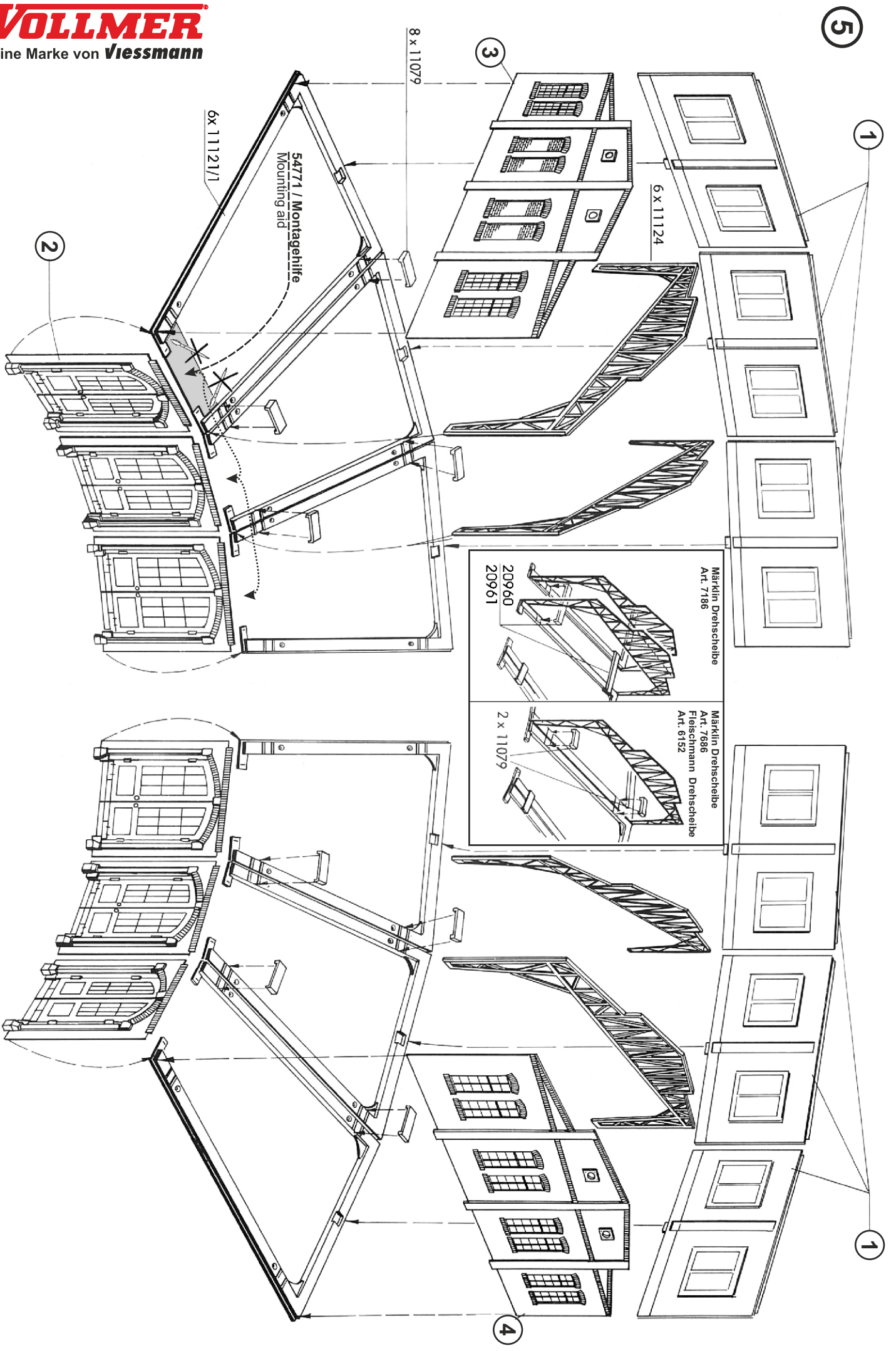

6

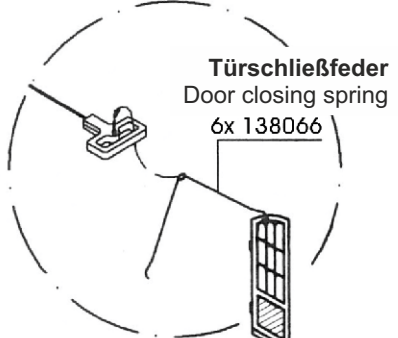
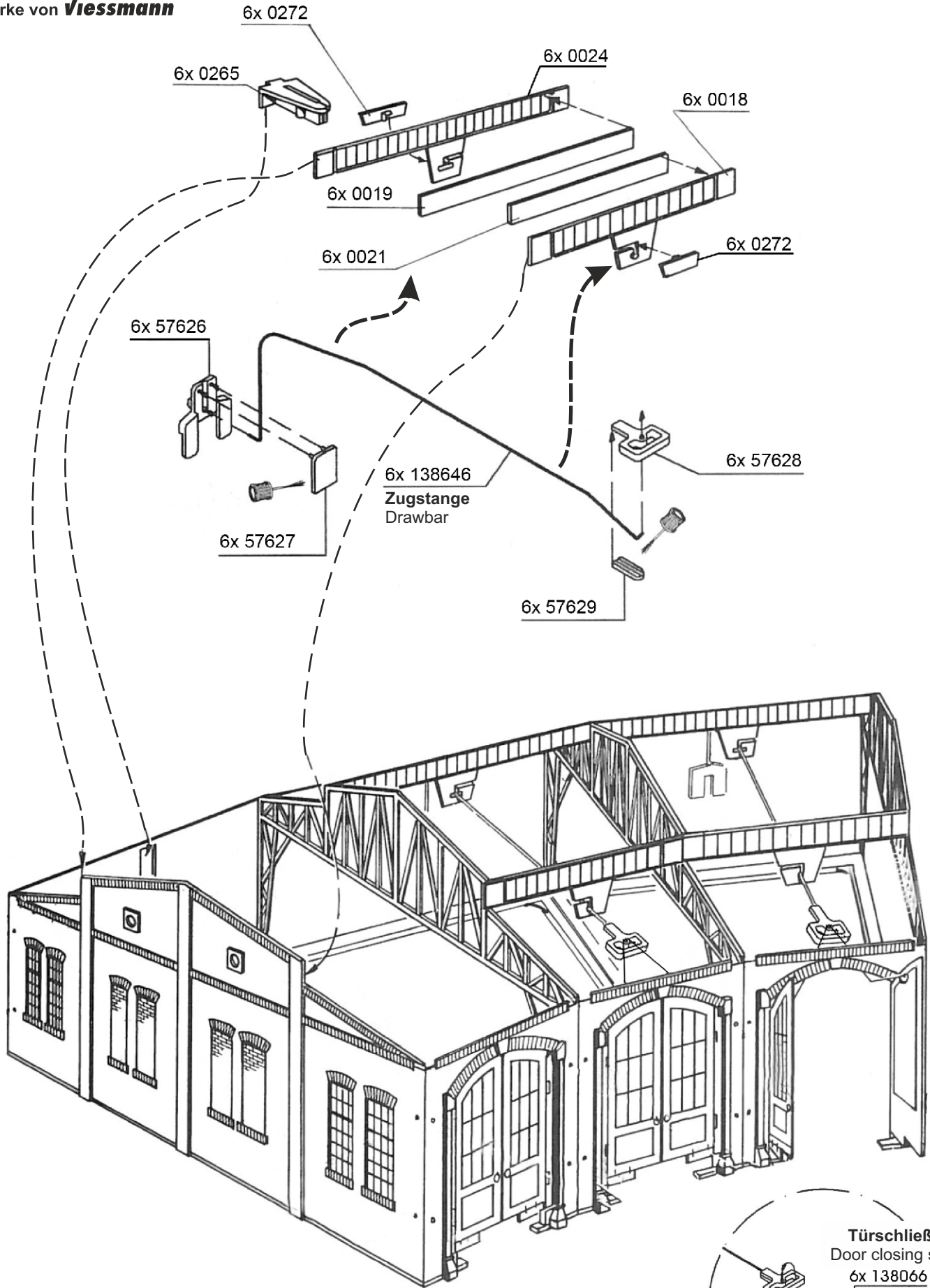

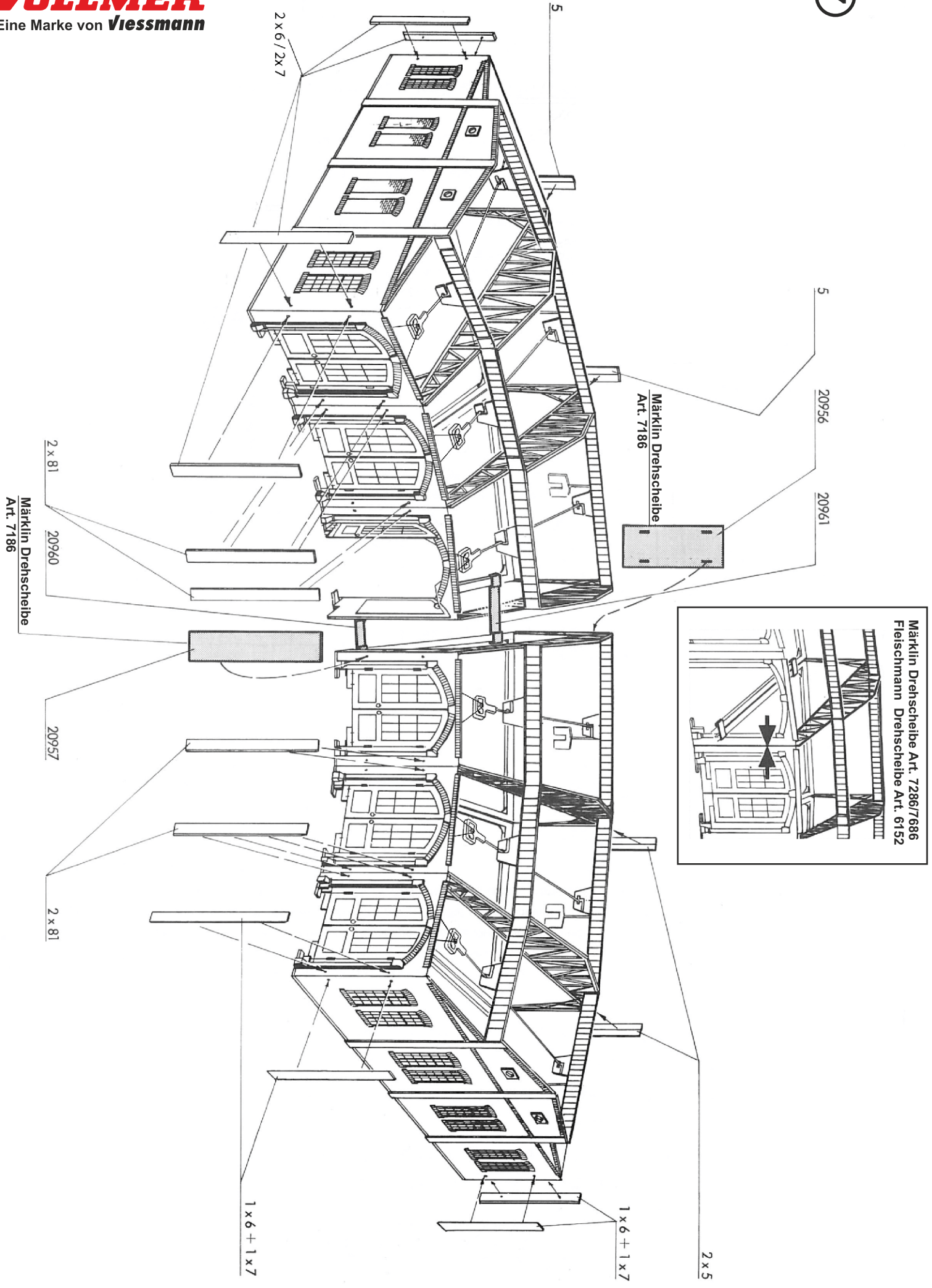

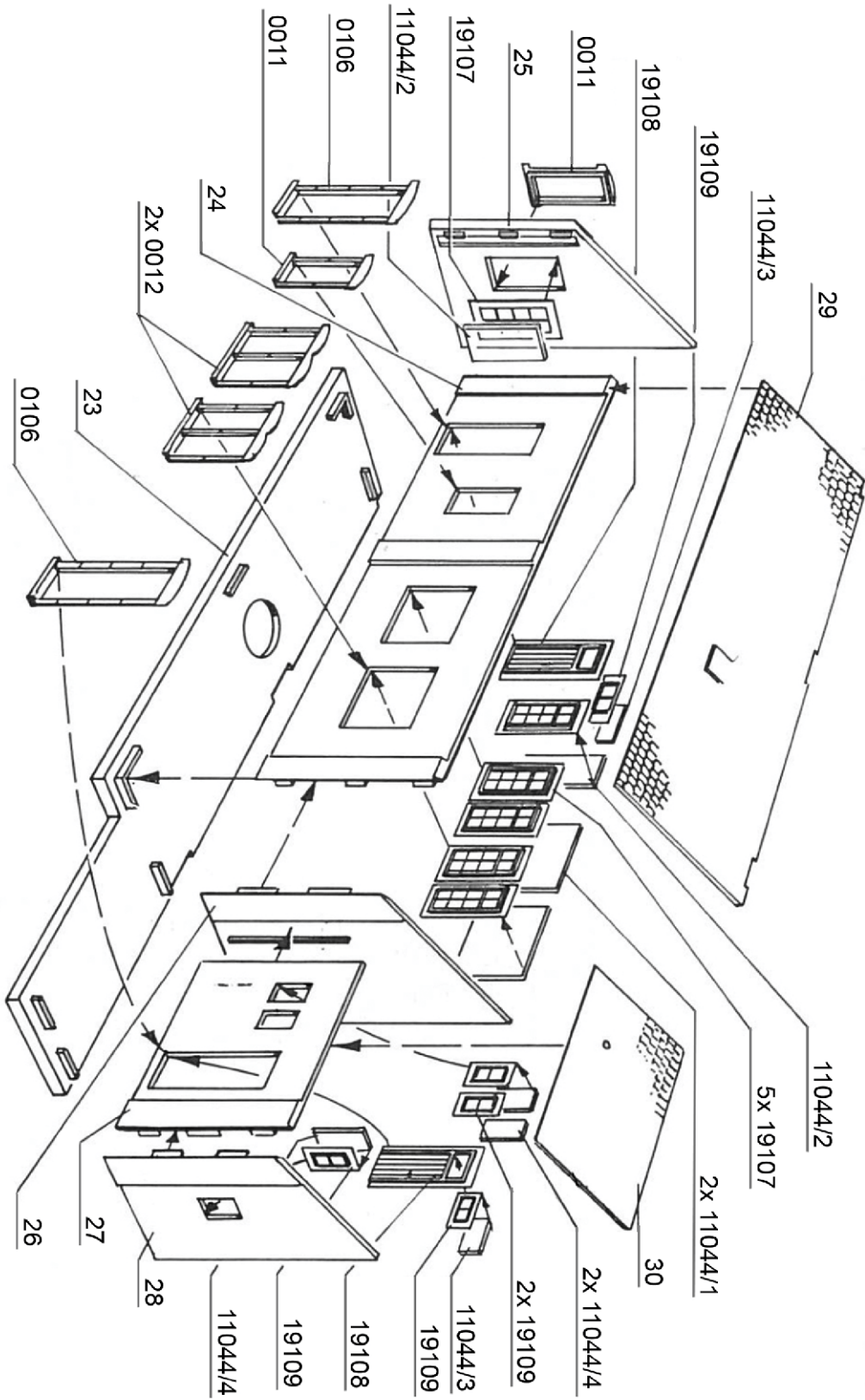

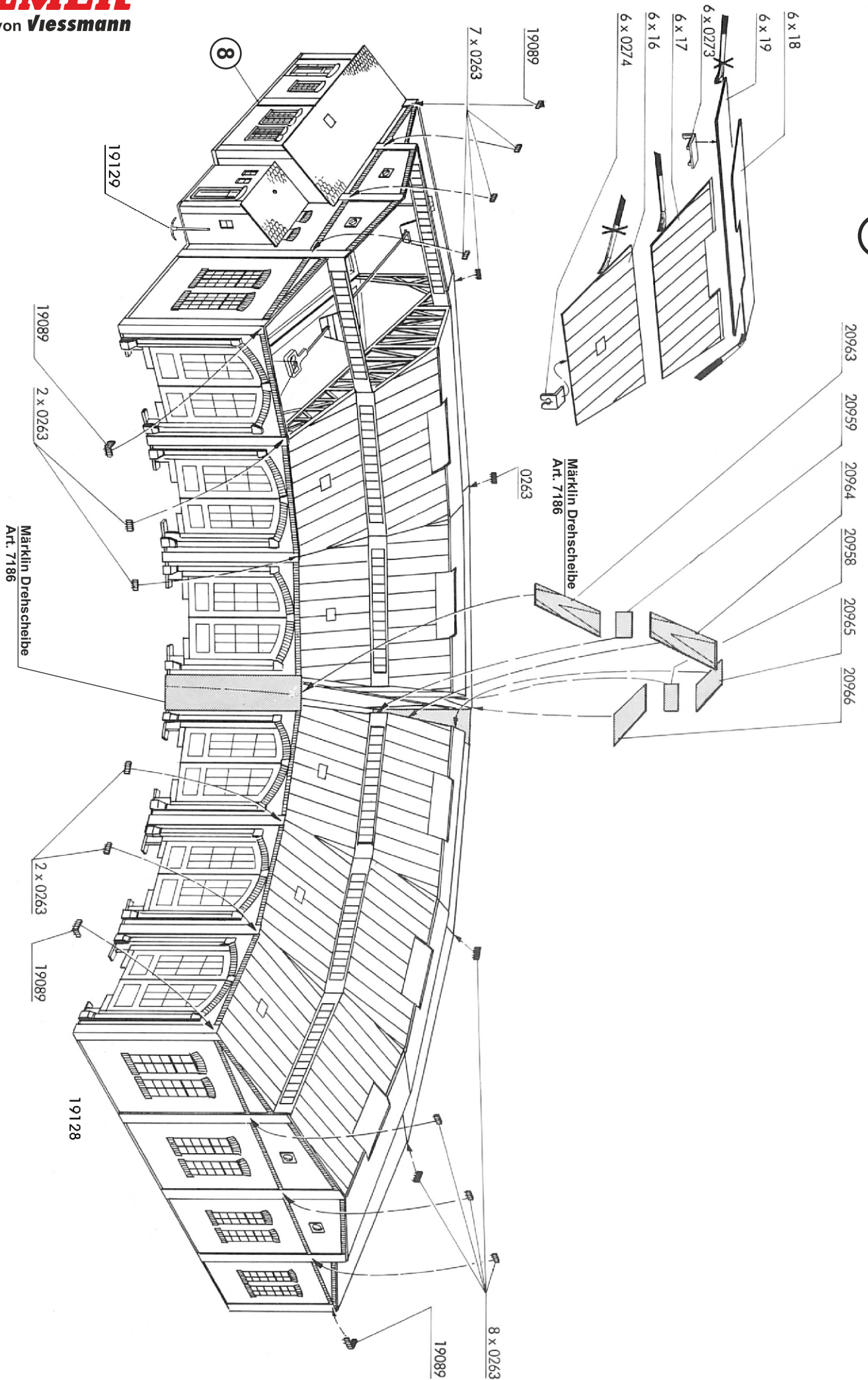

9

