

# 43756

## H0 Gerätehalle mit Turm, dreiständig

## H0 Engine house with tower, three track

(DE)

Bitte bauen Sie das Modell gemäß den einzelnen Montageschritten zusammen.

(EN)

Please assemble the model according to the individual assembly steps.

1. Inhalt .....	1	1. Contents .....	1
2. Montage .....	2	2. Mounting .....	2

### 1. Inhalt / Contents

Dekopapier / Decoration sheet: 135867

Spritzlingsnummer Sprue No.	Teile-Nr. Part No.	Stück Pieces	Spritzlingsnummer Sprue No.	Teile-Nr. Part No.	Stück Pieces	Spritzlingsnummer Sprue No.	Teile-Nr. Part No.	Stück Pieces		
21387	21371	1	21406	21401	1	21432	21427	7		
	21372	1		21402	1		21428	20		
	21373	2		21403	2		21429	11		
	21374	1		21404	1		21430	1		
	21375	1		21405	1		21431	1		
	21376	1		21413	21407		2	21439	21433	7
	21377	1			21408		1		21434	20
	21378	2			21409		1		21435	11
	21379	4			21410		2		21436	1
	21380	2			21411		1		21437	1
	21381	2		21412	1		21438		1	
	21382	2		21426	21414		2			
	21383	1			21415		2			
	21384	1			21416		4			
	21385	2			21417		1			
	21386	1	21418		2					
	21397	21388	2	21419	3					
		21389	2	21420	3					
		21390	4	21421	4					
		21391	3	21422	4					
21392		3	21423	4						
21393		2	21424	1						
21394		1	21425	2						
21395		2								
21396	2									
21398	21398	1								

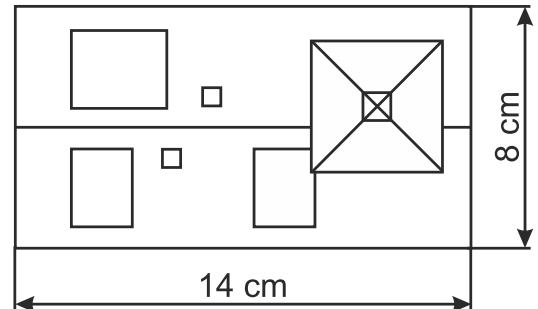

(DE)

Dieser Bausatz besteht aus dem recyclefähigen Kunststoff Polystyrol.

(EN)

This kit consists of recyclable polystyrene.



## 2. Montage / Mounting

① 2x

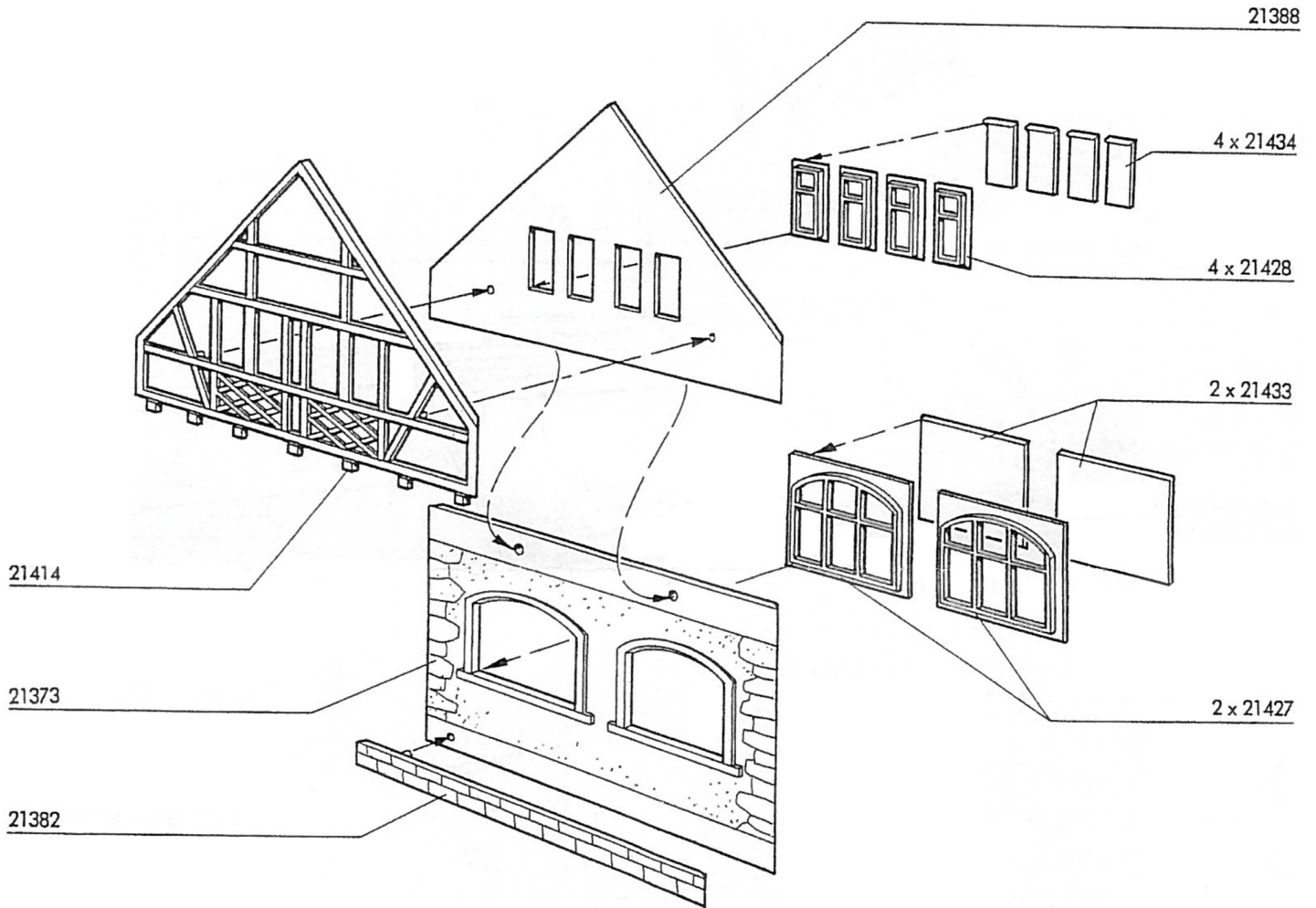

2

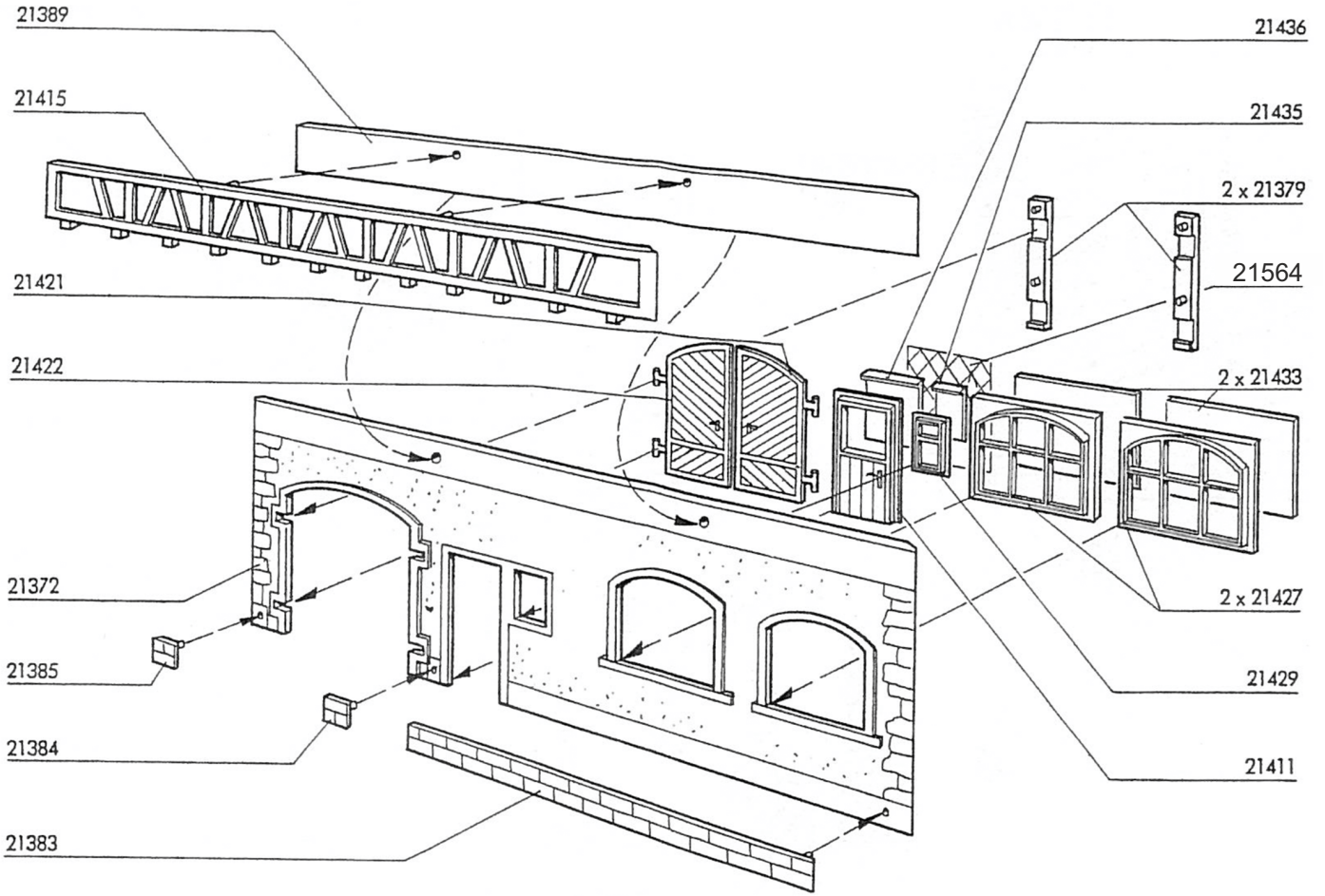

3

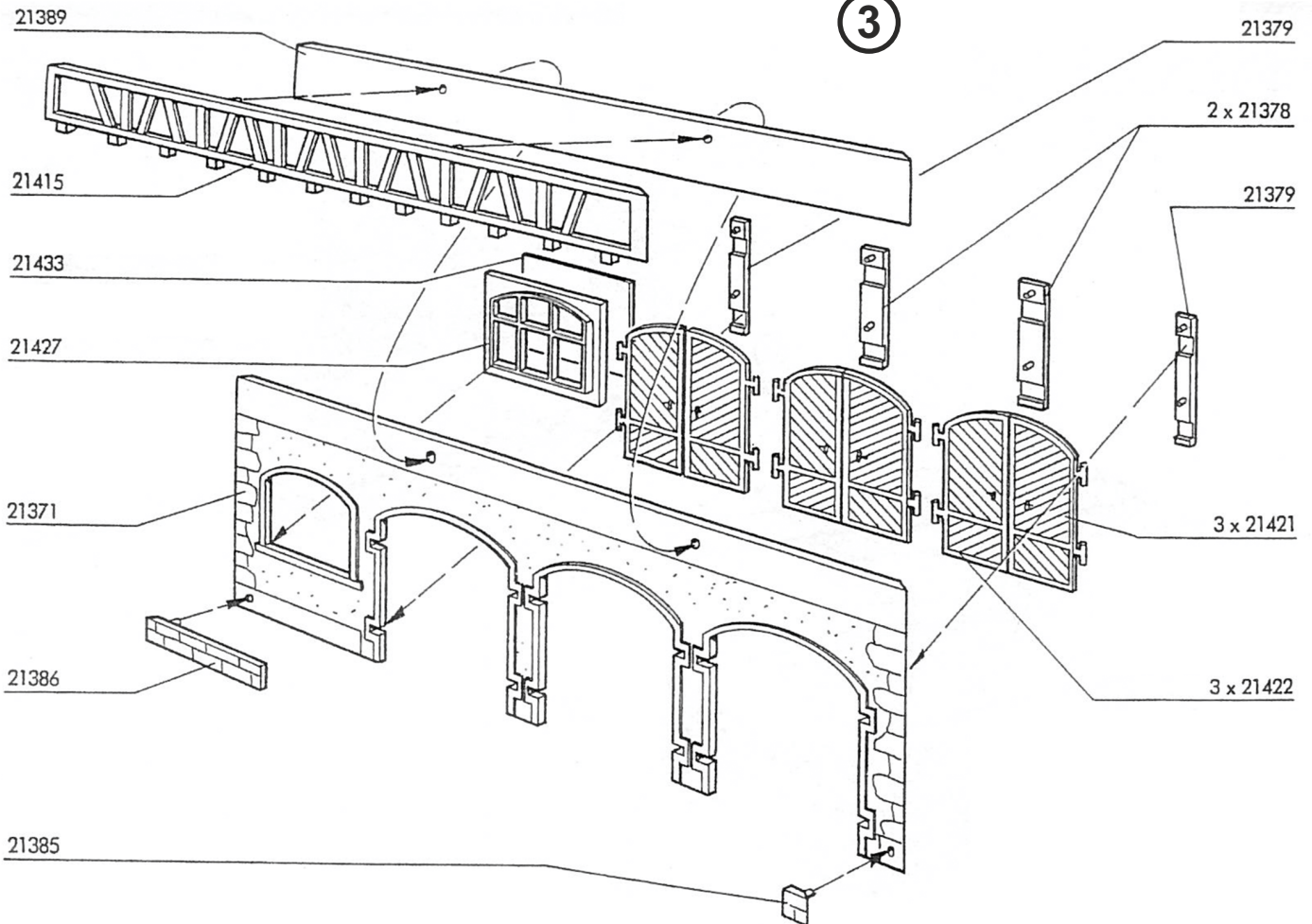

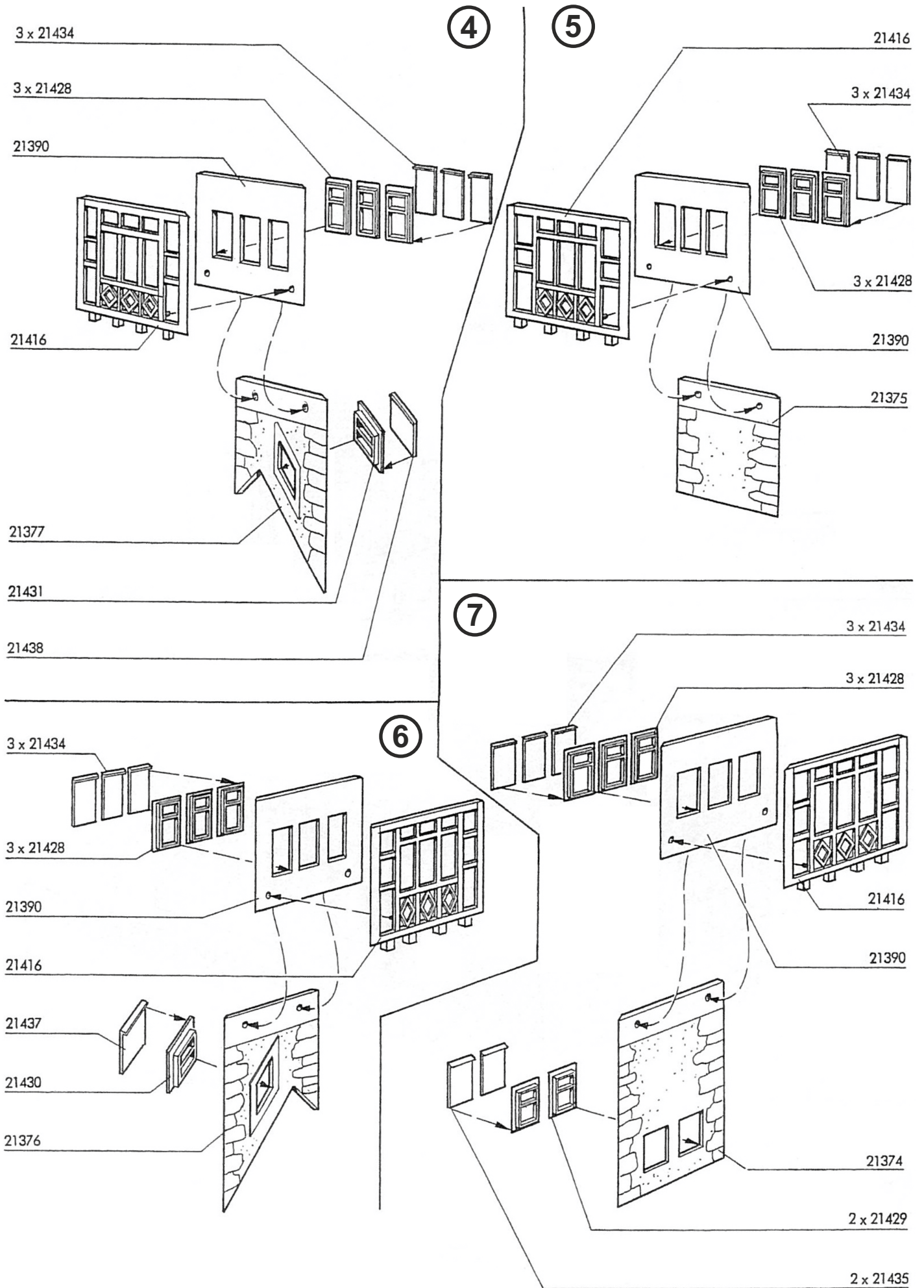

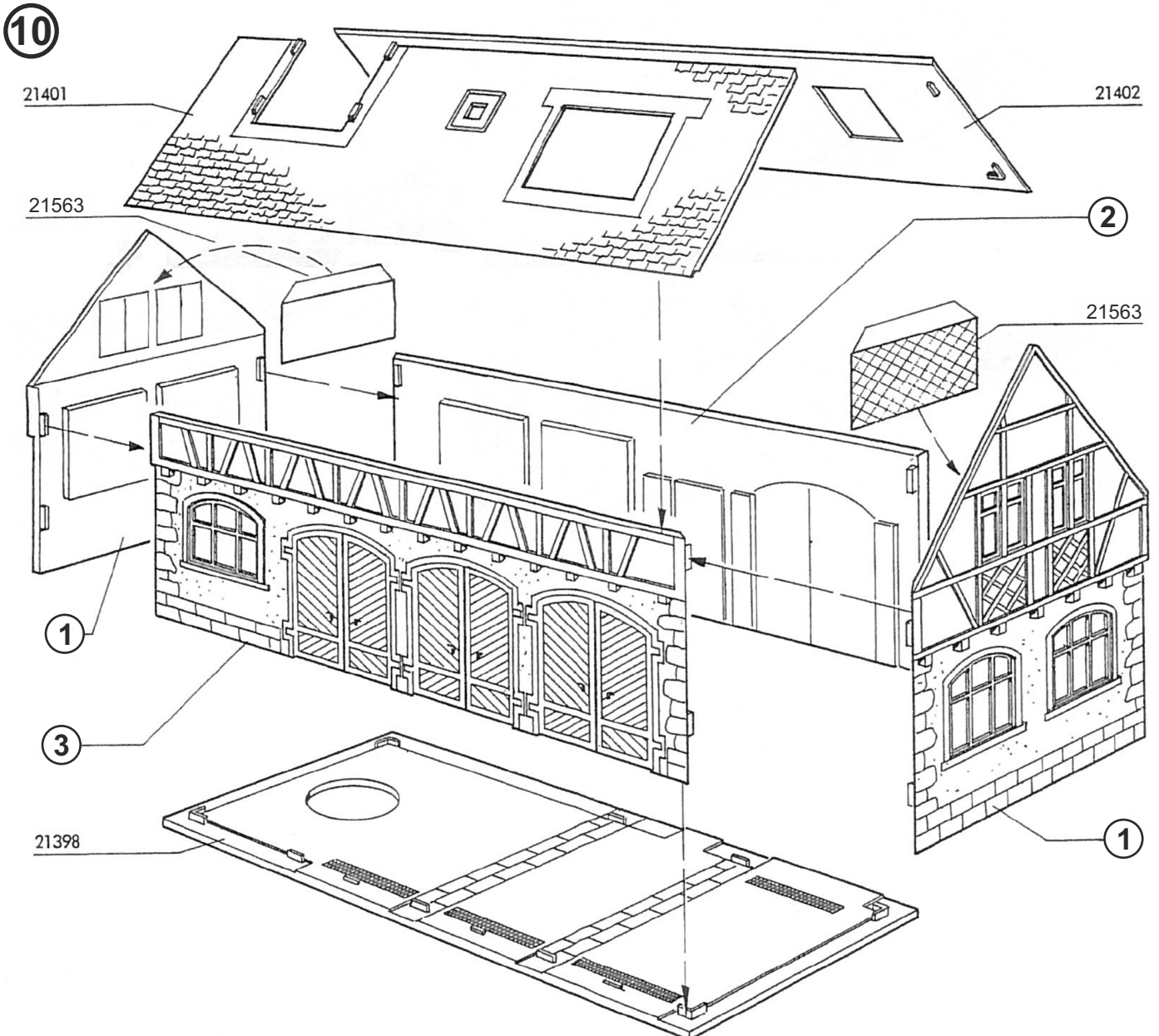
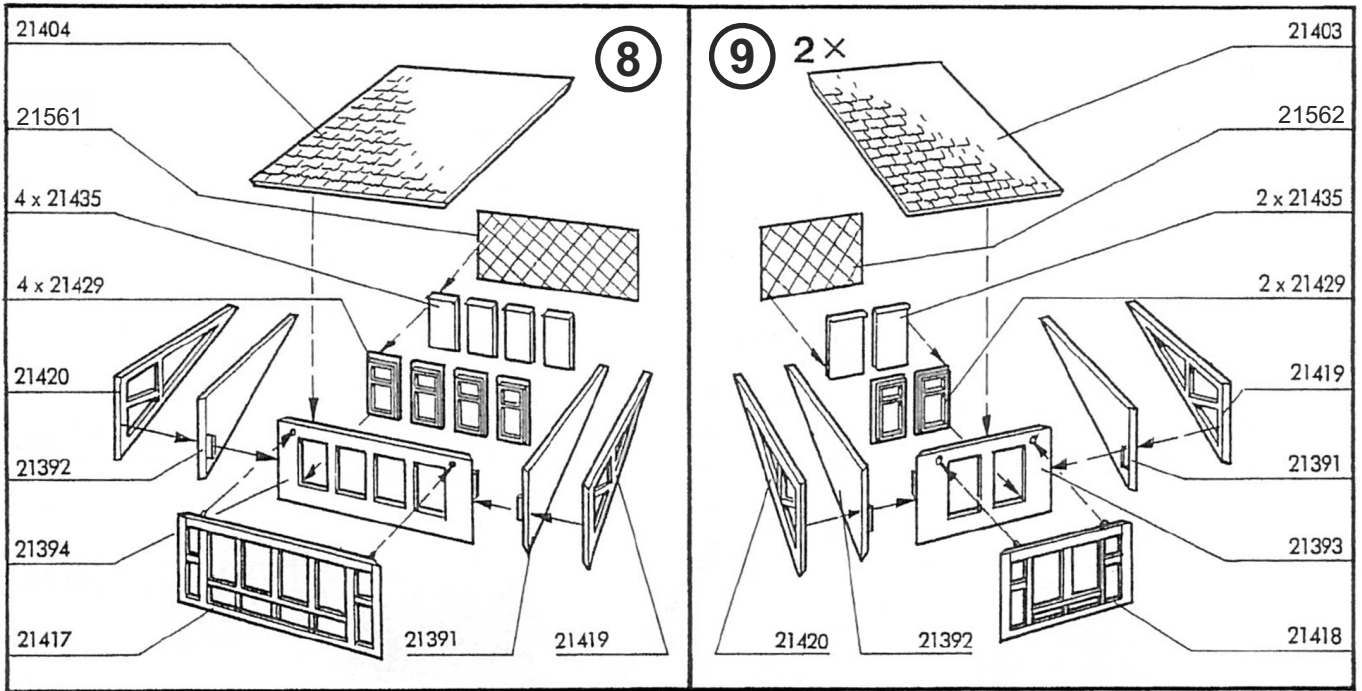

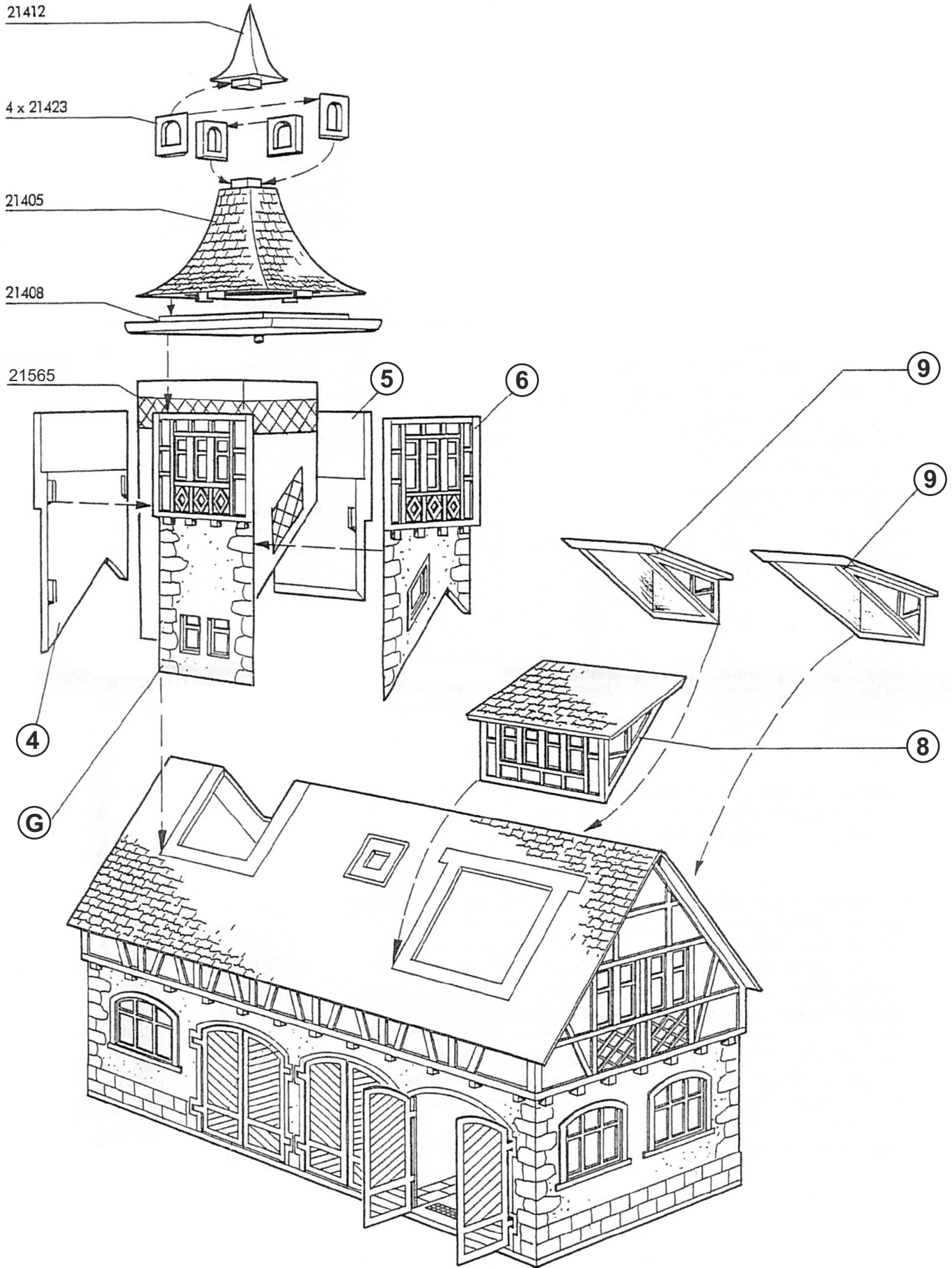

**Tipp:**  
Möchten Sie das Modell von innen beleuchten, verwenden Sie bitte die **viessmann Art. 6832** Hausbeleuchtungssockel mit Glühlampe E5,5, klar.

**Tip:**  
To illuminate the model from inside, please use **viessmann item 6832** House illumination socket with bulb E5,5, clear.

13

