

Montageanleitung

H0 Dorffeuerverehr, sechsständig

Mounting instruction

H0 Village fire station, six track

(DE)

Bitte legen Sie die Einzelteile nach Buchstabengruppen zusammen und beginnen Sie dann entsprechend der Zeichnungen mit dem Zusammenbau.

(EN)

Arrange the individual parts by letter groups, and then begin assembling in accordance with the drawings.

1. Inhalt	1	1. Contents	1
2. Montage	2	2. Mounting	2

1. Inhalt/Contents Dekopapier: 139579

Spr.-Nr.	Teile-Nr.	Stück	Spr.-Nr.	Teile-Nr.	Stück	Spr.-Nr.	Teile-Nr.	Stück	Spr.-Nr.	Teile-Nr.	Stück
21358	21350	1	21387	21371	1	21397	21388	2	21426	21414	2
	21351	1		21372	1		21389	2		21415	2
	21352	2		21373	2		21390	4		21416	4
	21353	2		21374	1		21391	3		21417	1
	21354	2		21375	1		21392	3		21418	2
	21355	1		21376	1		21393	2		21419	3
	21356	2		21377	1		21394	1		21420	3
	21357	2		21378	2		21395	2		21421	4
				21379	4		21396	2		21422	4
21362	21359	1		21380	2					21423	4
	21360	2		21381	2	21398	21398	1		21424	1
	21361	2		21382	2					21425	2
				21383	1	21413	21407	2			
21363	21363	1		21384	1		21408	1	21439	21433	7
				21385	2		21409	1		21434	20
21365	21364	7		21386	1		21410	2		21435	11
							21411	1		21436	1
21367	21366	7	21406	21401	1		21412	1		21437	1
				21402	1					21438	1
21370	21368	3		21403	2	21432	21427	7			
	21369	3		21404	1		21428	20			
				21405	1		21429	11			
							21430	1			
							21431	1			

(DE)

Wir verwenden den recyclefähigen Kunststoff Polystyrol.

Wir gratulieren Ihnen zum Erwerb dieses hochwertigen Vollmer-Bausatzes. Die hohe Passgenauigkeit unserer Bausätze wird Ihnen viel Freude bereiten.

Diverse Kleber für die Bausätze finden Sie im Vollmer Sortiment.

Änderungen vorbehalten.

Keine Haftung für Druckfehler und Irrtümer.

(EN)

We use recyclable polystyrene.

Congratulations on your purchase of this Vollmer product. Our high quality kits will bring you much joy.

You will find various glues for the kits in the Vollmer product range.

Subject to change without prior notice.

No liability for mistakes and printing errors.

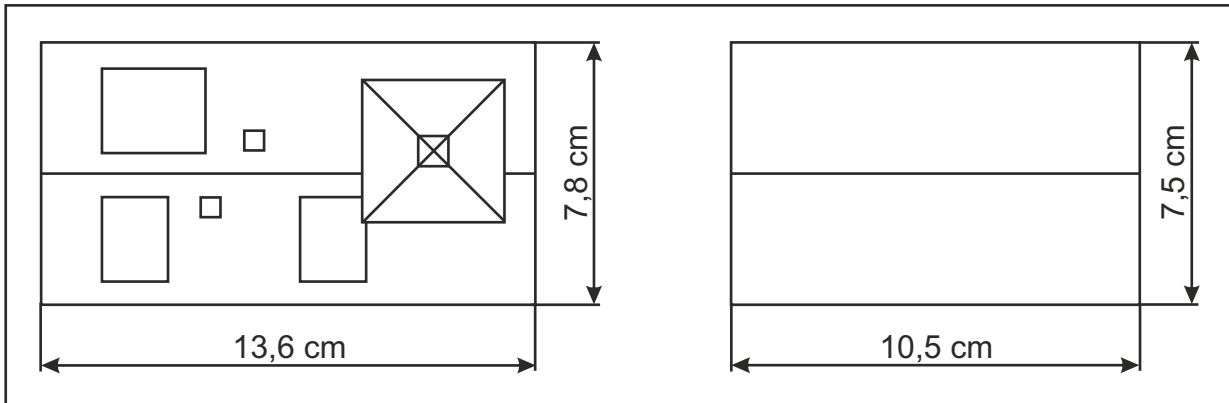

2. Montage
Mounting

A 2x

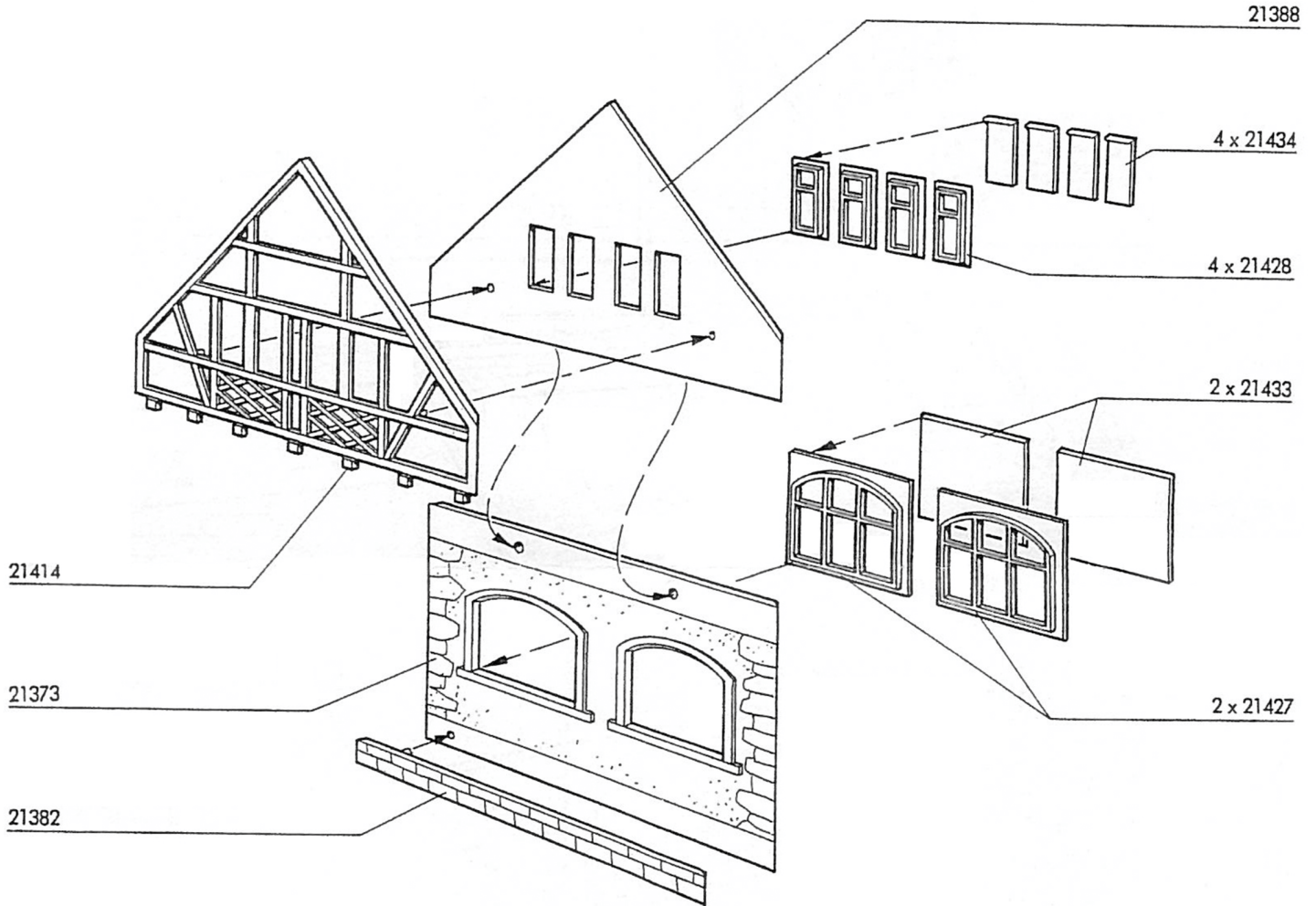

(B)

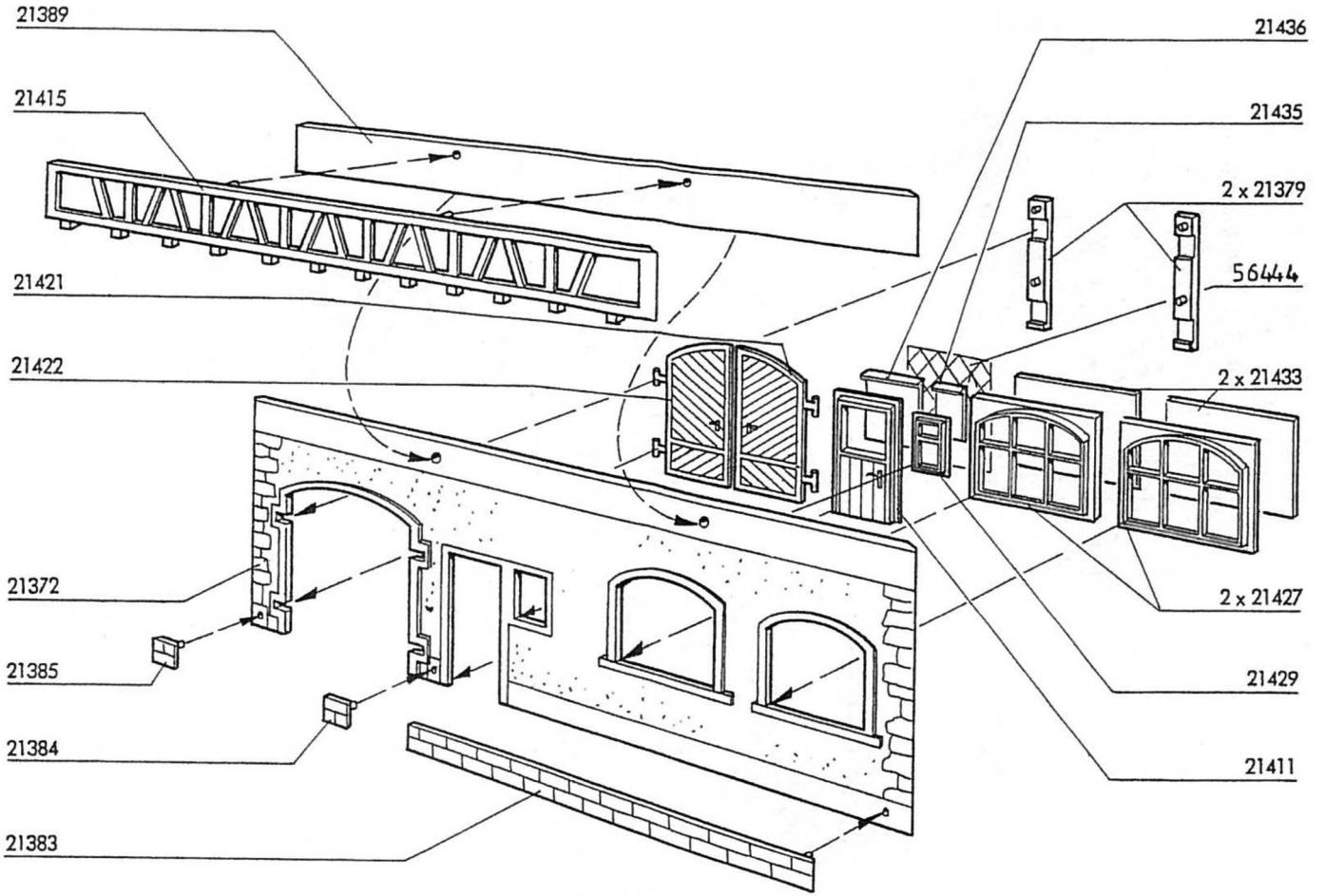

(C)

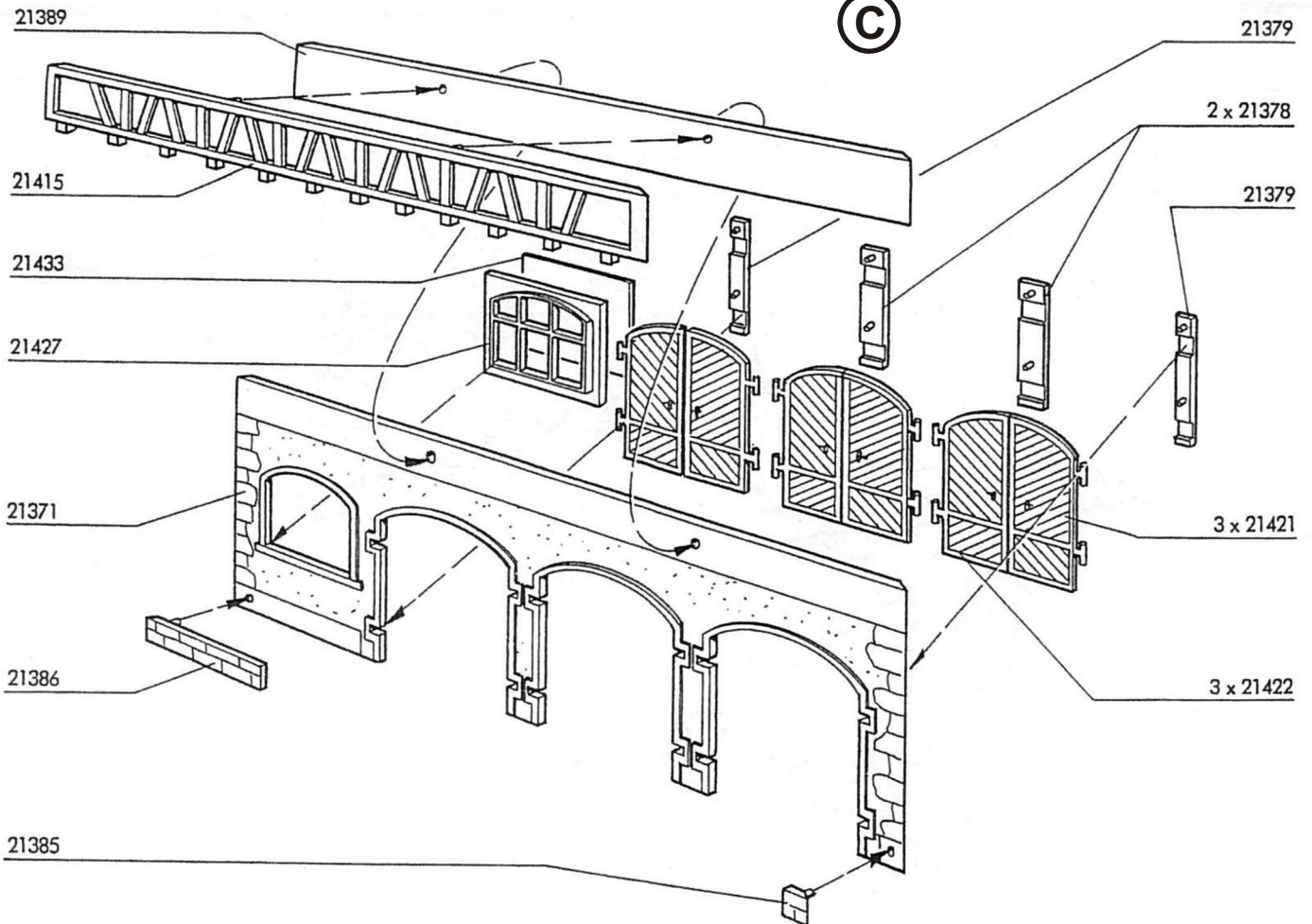

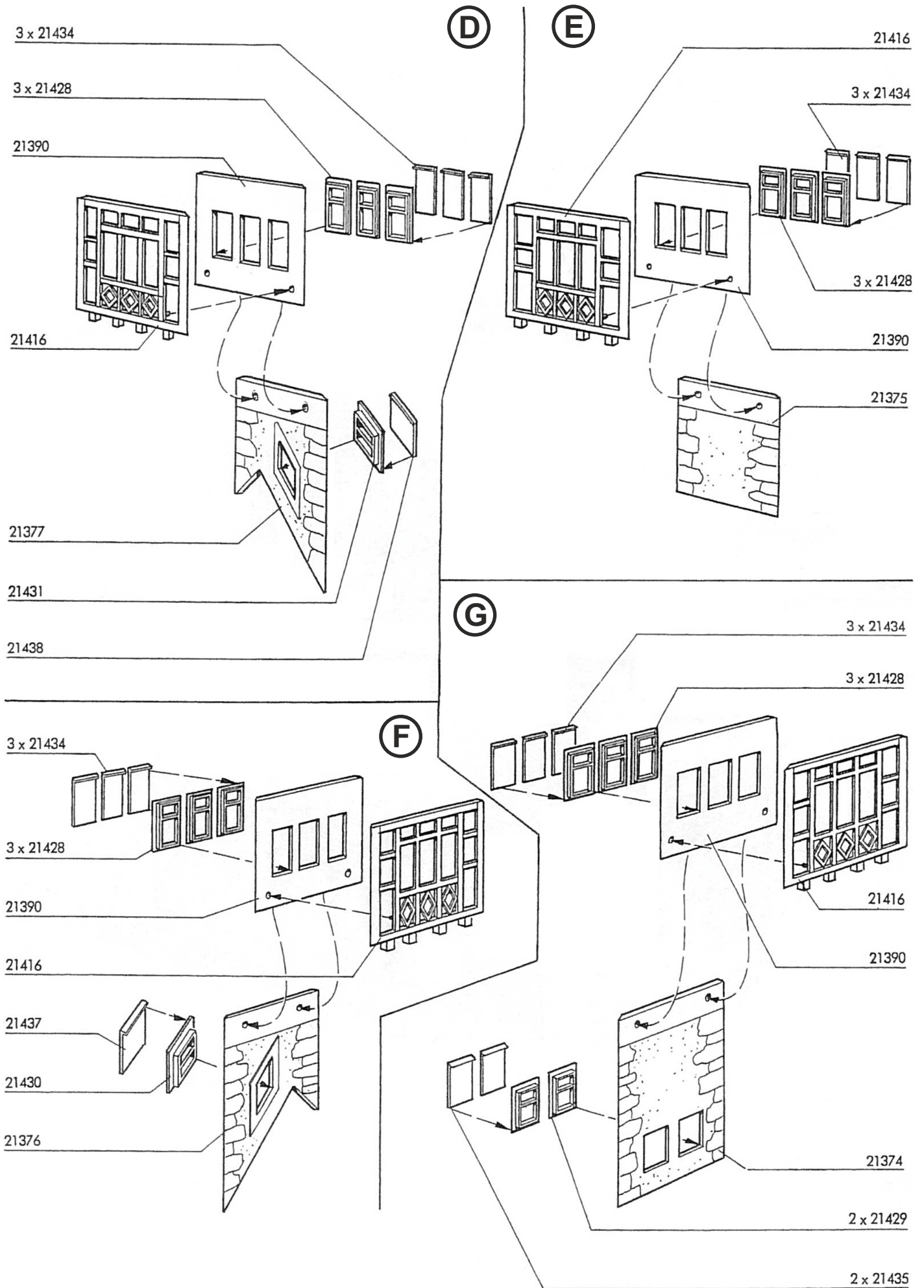

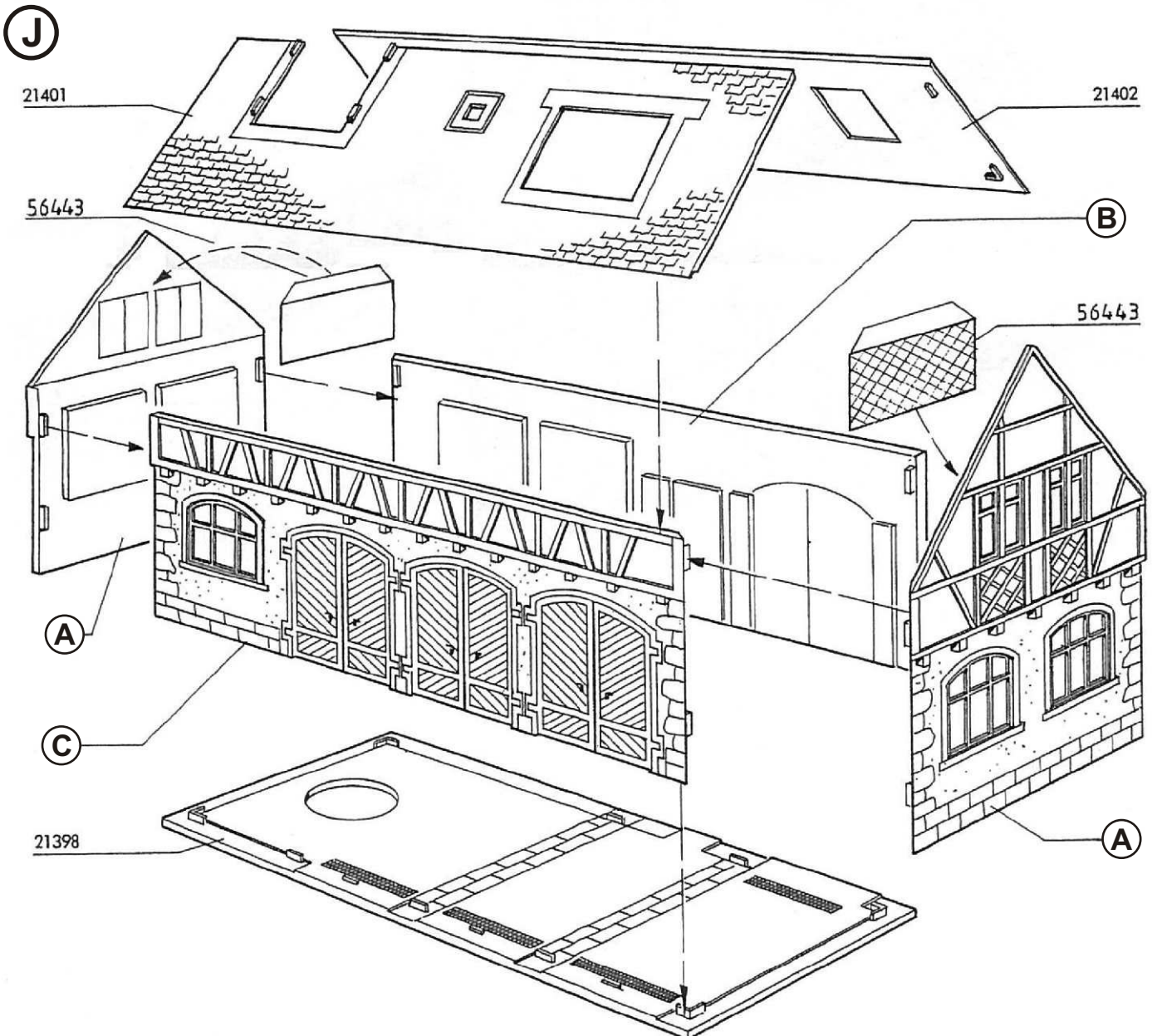
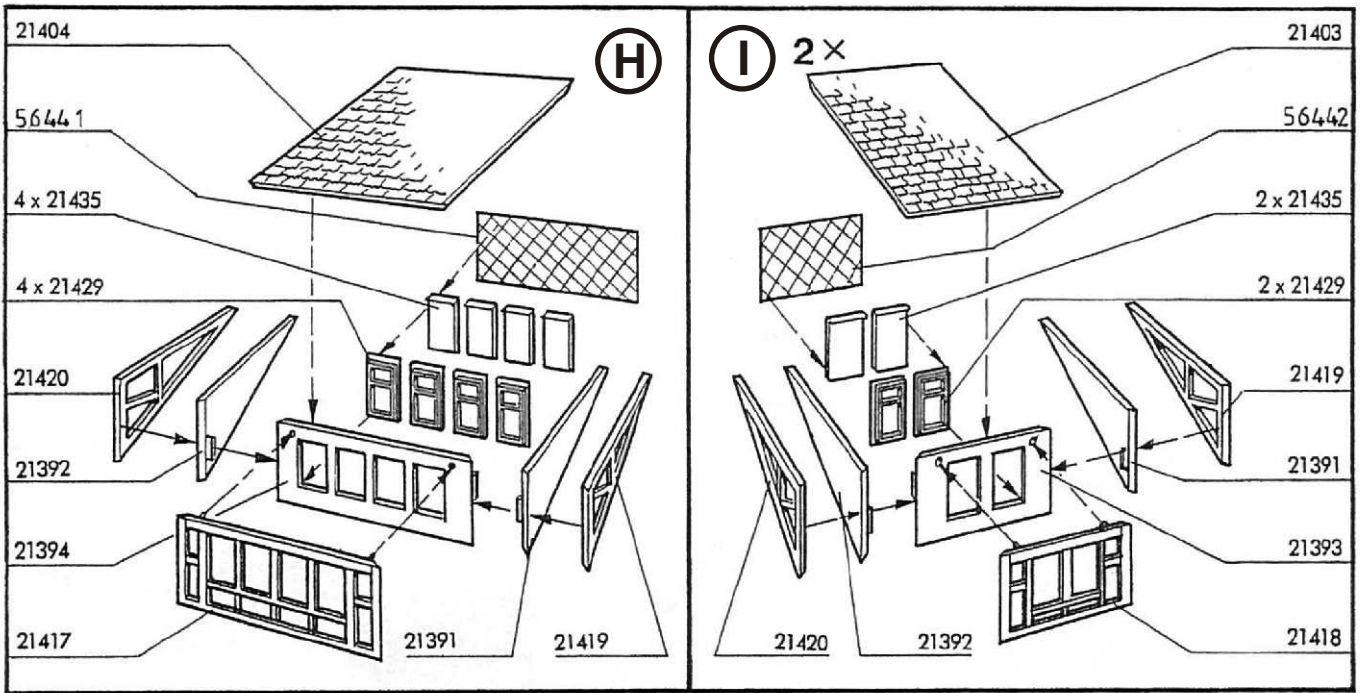

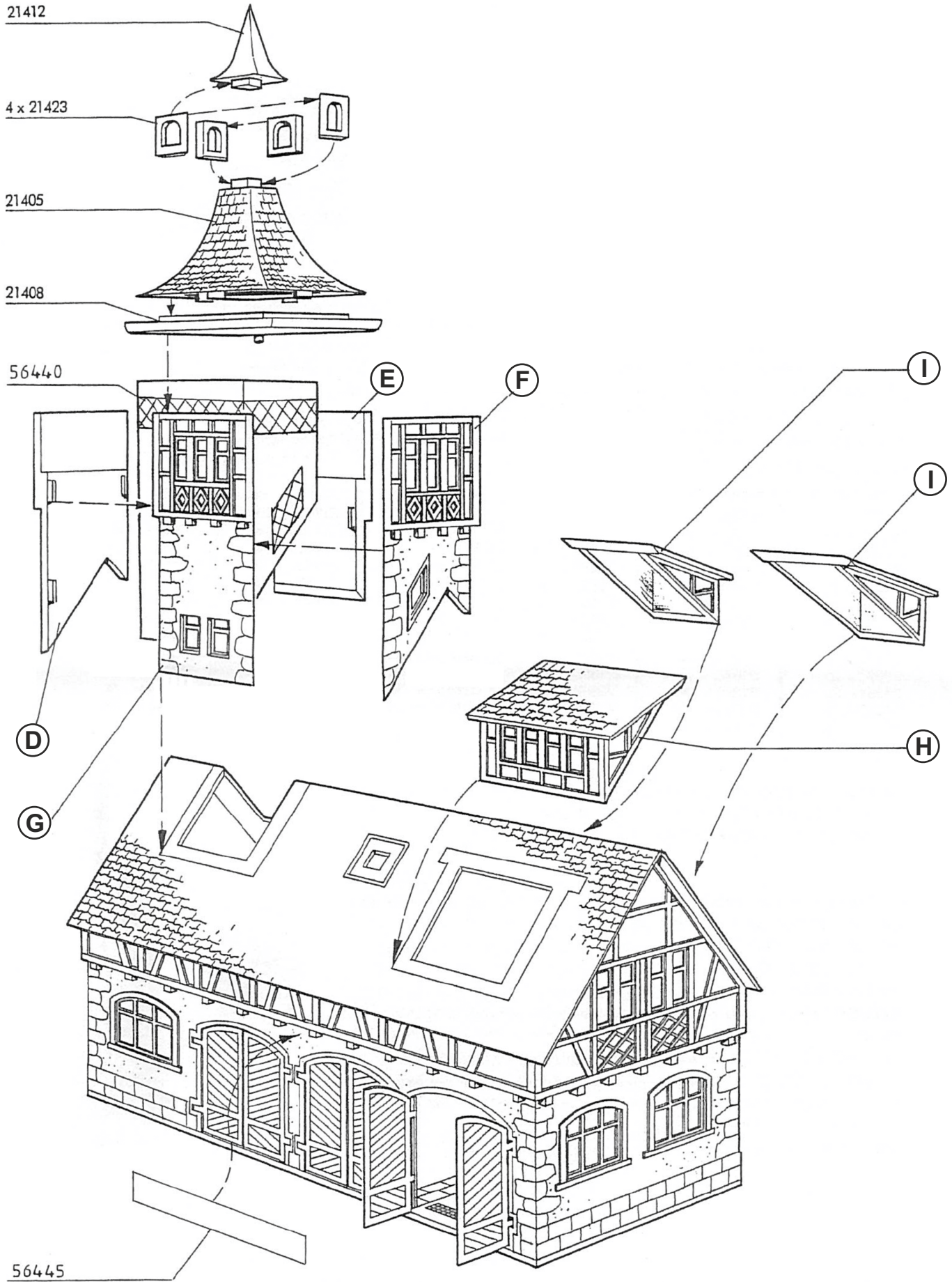

Tipp:
Möchten Sie das Modell von innen beleuchten, verwenden Sie bitte die **viessmann Art. 6832** Hausbeleuchtungssockel mit Glühlampe E5,5, klar.

Tip:
To illuminate the model from inside, please use **viessmann item 6832** House illumination socket with bulb E5,5, clear.

