

# 47738

## N Brennendes Haus

### N House on fire

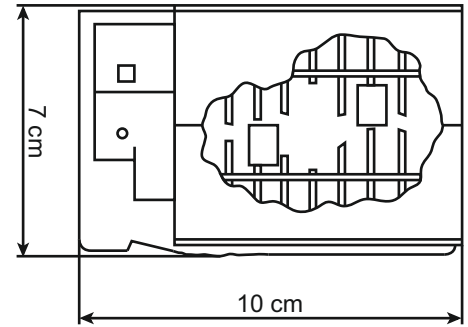

**(DE)**

Bitte bauen Sie das Modell gemäß den einzelnen Montageschritten zusammen.

1. Inhalt ..... 1  
2. Montage ..... 2

**(EN)**

Please assemble the model according to the individual assembly steps.

1. Contents ..... 1  
2. Mounting ..... 2

### 1. Inhalt / Contents

Dekopapier / Decoration sheet: 139020 Farbtabelle / Colour tablet: 138653

Spritzlingsnummer Sprue No.	Teile-Nr. Part No.	Stück Pieces	Spritzlingsnummer Sprue No.	Teile-Nr. Part No.	Stück Pieces	Spritzlingsnummer Sprue No.	Teile-Nr. Part No.	Stück Pieces			
22389	22373	1	23250	23242	1	26061	26048	1			
	22374	1		23243	1		26049	1			
	22375	1		23244	1		26050	1			
	22376	1		23245	1		26051	1			
	22377	1		23246	1		26054	26054	1		
	22378	1		23247	1			26055	1		
	22379	1		23248	1			26056	1		
	22380	1		23249	1			26057	1		
	22381	1		23263	23251			1	26058	2	
	22385	2			23252			1	26059	2	
	22386	2			23253			1	26060	2	
	22409	22404		22	23275		23254	1	26074	26062	1
		22405		1			23255	1		26063	1
		22406		1			23256	1		26064	1
22408		2	23257	1		26065	1				
23238		23223	26	26052		23258	1	26087		26066	1
		23224	1			23259	1			26067	1
	23226	1	23260		1	26068	1				
	23227	2	23261		23261	1	26069		1		
	23228	3			23262	1	26070		1		
	23229	1			23264	1	26071		1		
	23230	1	23265		1	26072	1				
	23231	1	23266		1	26073	1				
	23232	1	23267		1	26075	26075		1		
	23241	23233	1		23268		1		26076	1	
		23234	1		23269		1		26077	1	
23235		1	23270	1	26078		1				
23236		2	23274	1	26079		1				
23237		1	23556	1	26080		1				
23241		23239	1	26043	1		26081	1			
				26044	1		26082	1			
				26045	1		26083	1			
				26046	4		26084	1			
				26047	3	26085	1				
						26086	1				

**(DE)**

Dieser Bausatz besteht aus dem recyclefähigen Kunststoff Polystyrol.

**(EN)**

This kit consists of recyclable polystyrene.



**2. Montage / Mounting**

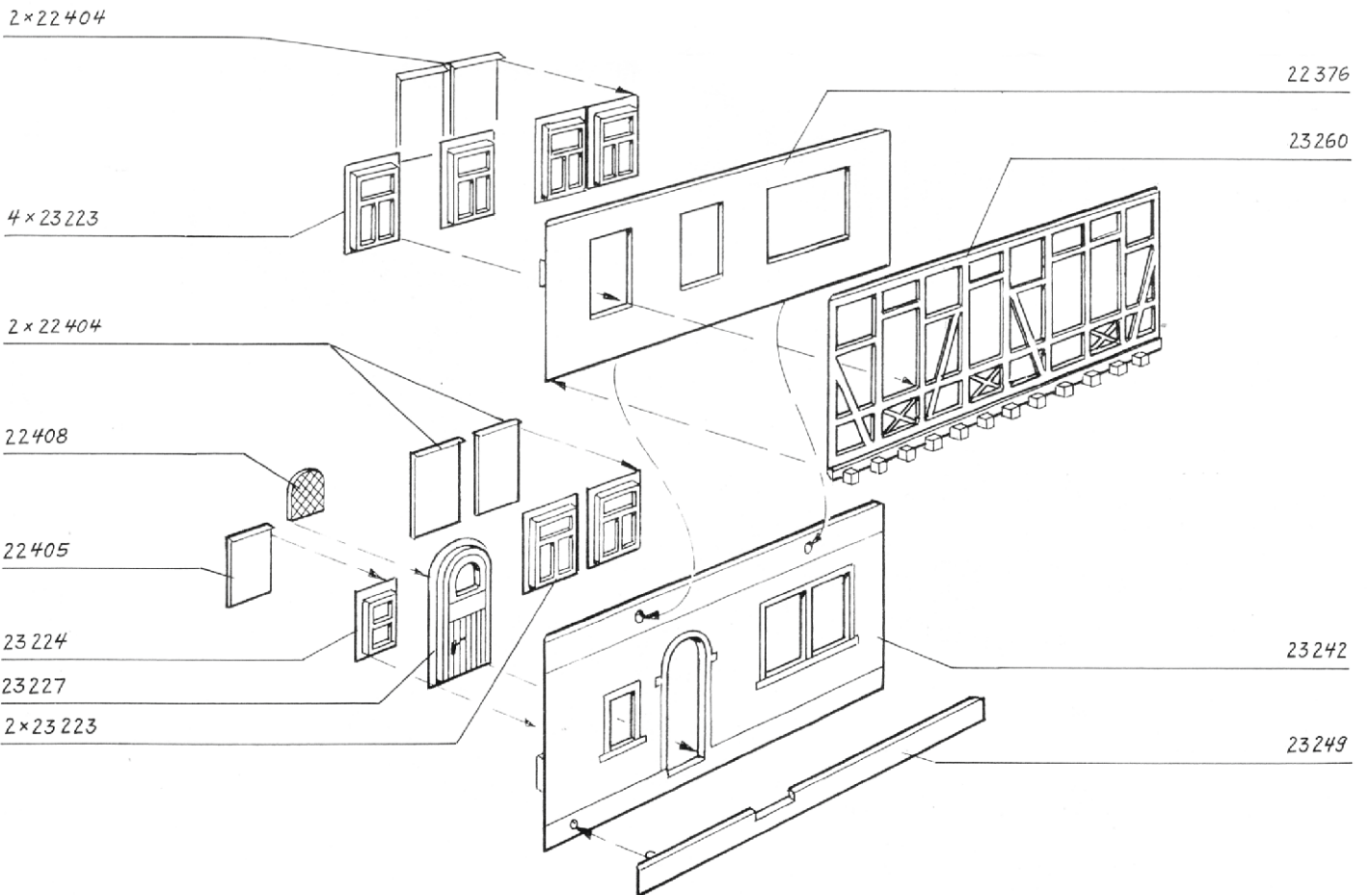
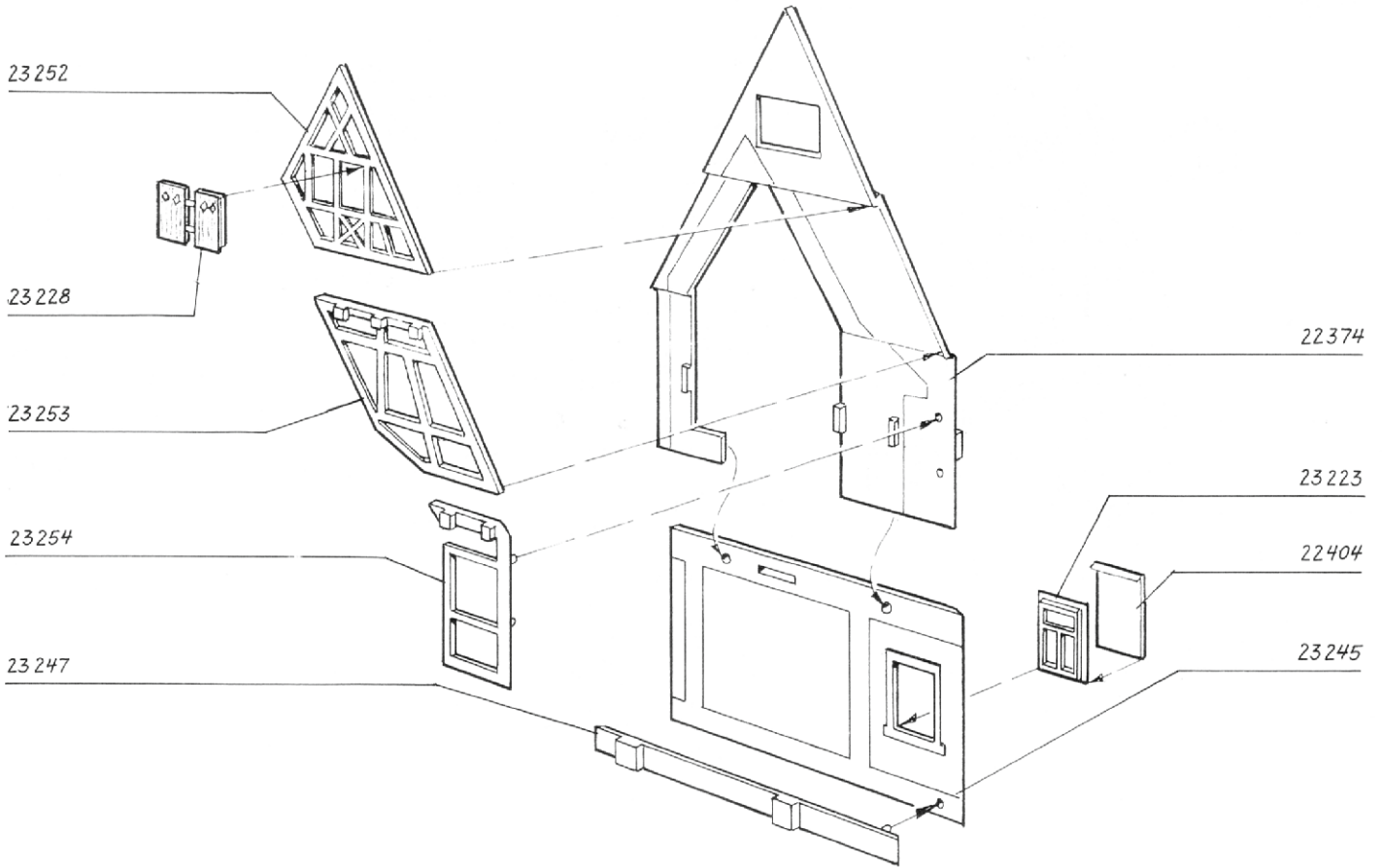

3



4



5

6

7

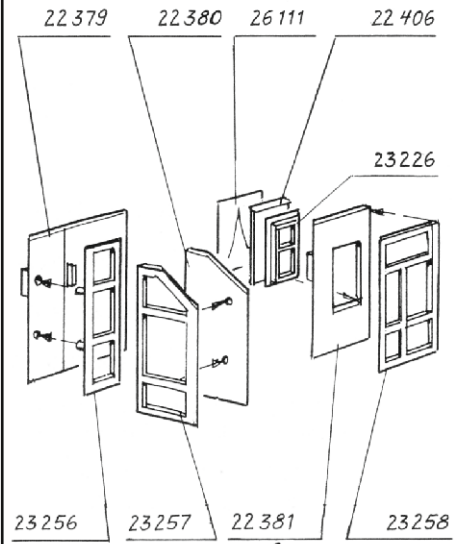
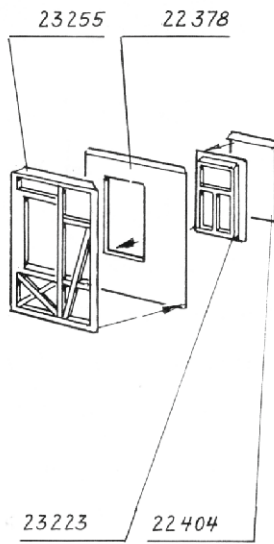
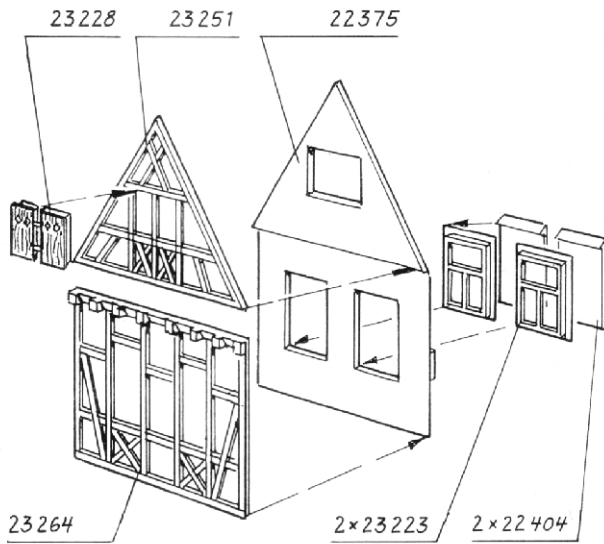

8

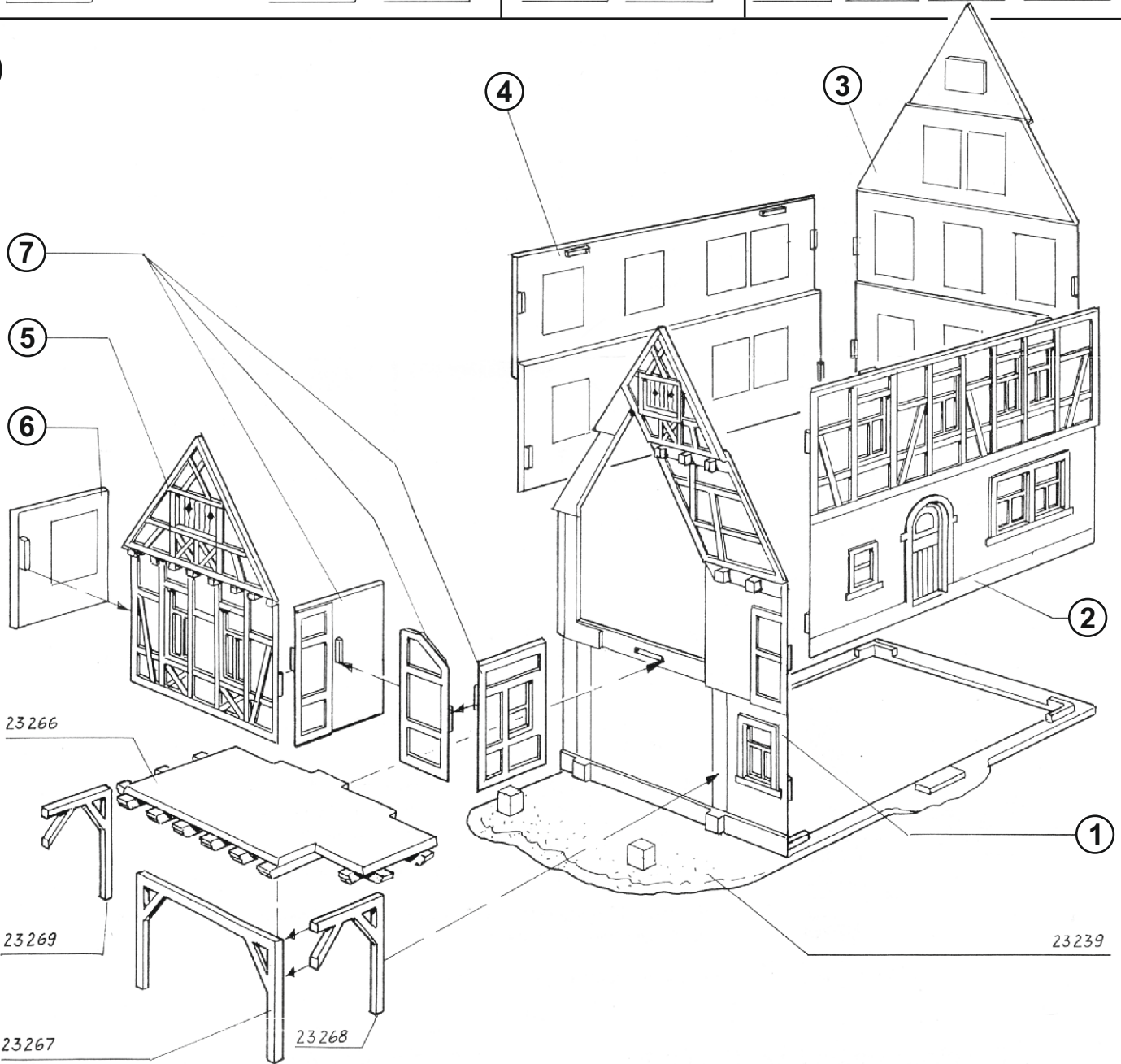

2x **9**

2x **10**

**11**

26059

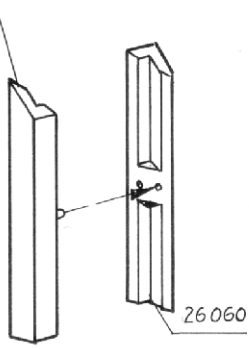

26060

26058

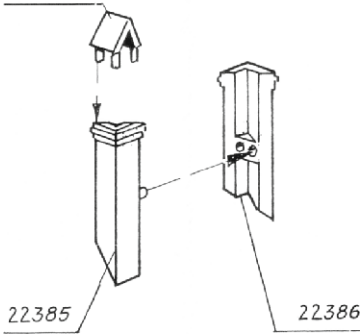

22385

22386

22387

22388

**12**

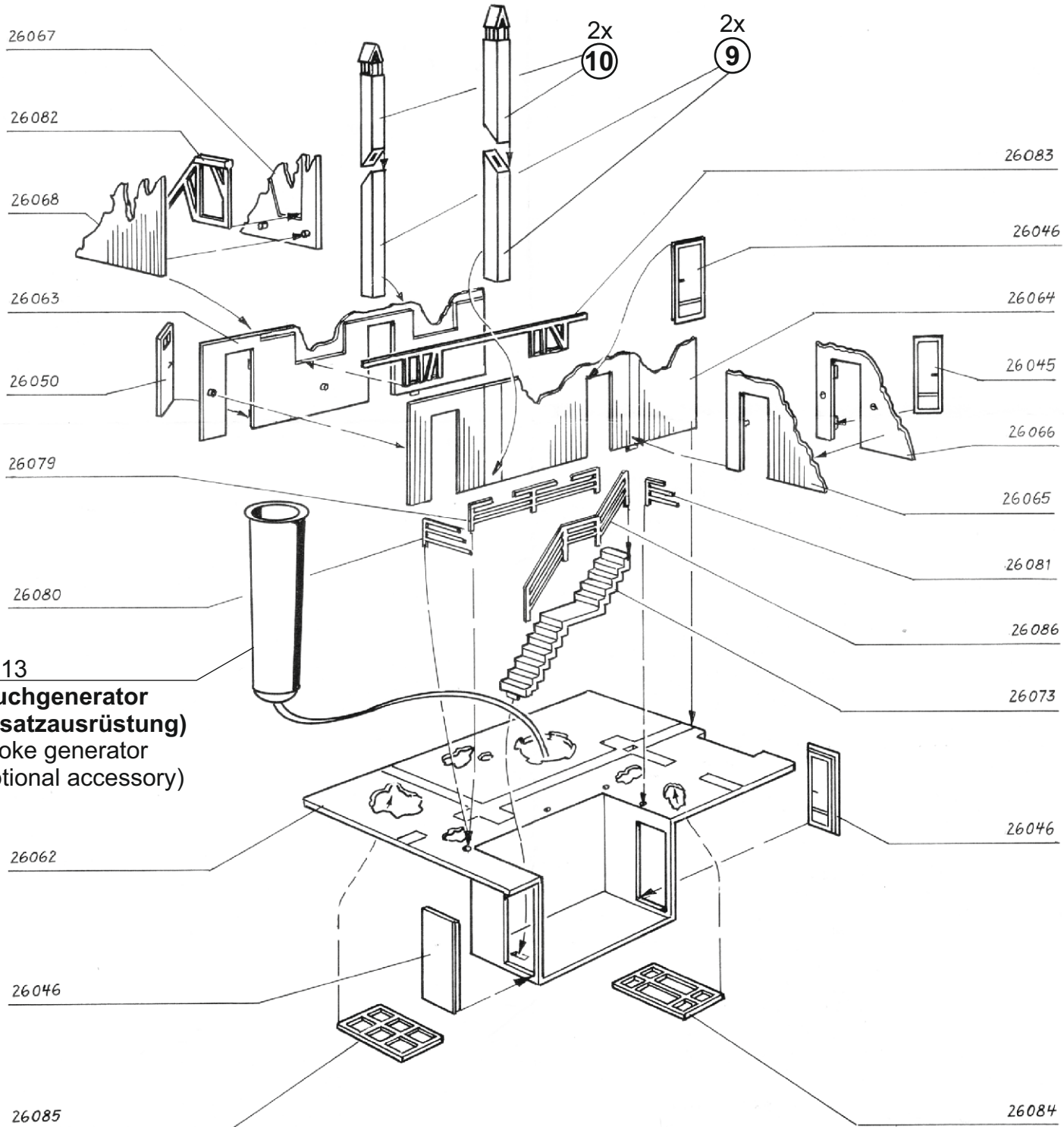

**44113**  
**Rauchgenerator**  
**(Zusatzausrüstung)**  
Smoke generator  
(Optional accessory)

13

26046

26070

26069

39020

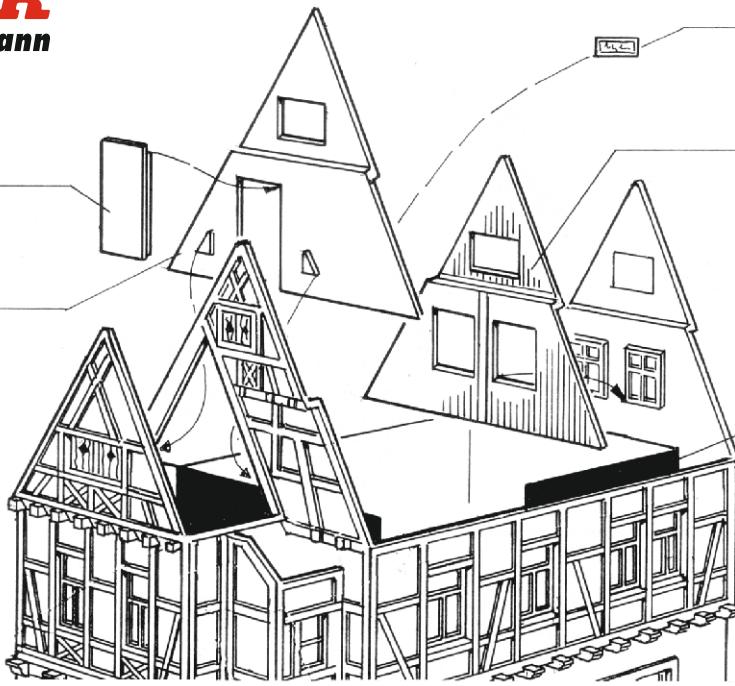

14

26048

26047

26043

26044

26051

26112

2x 26047

26049

26112

26078

26112

12

26110

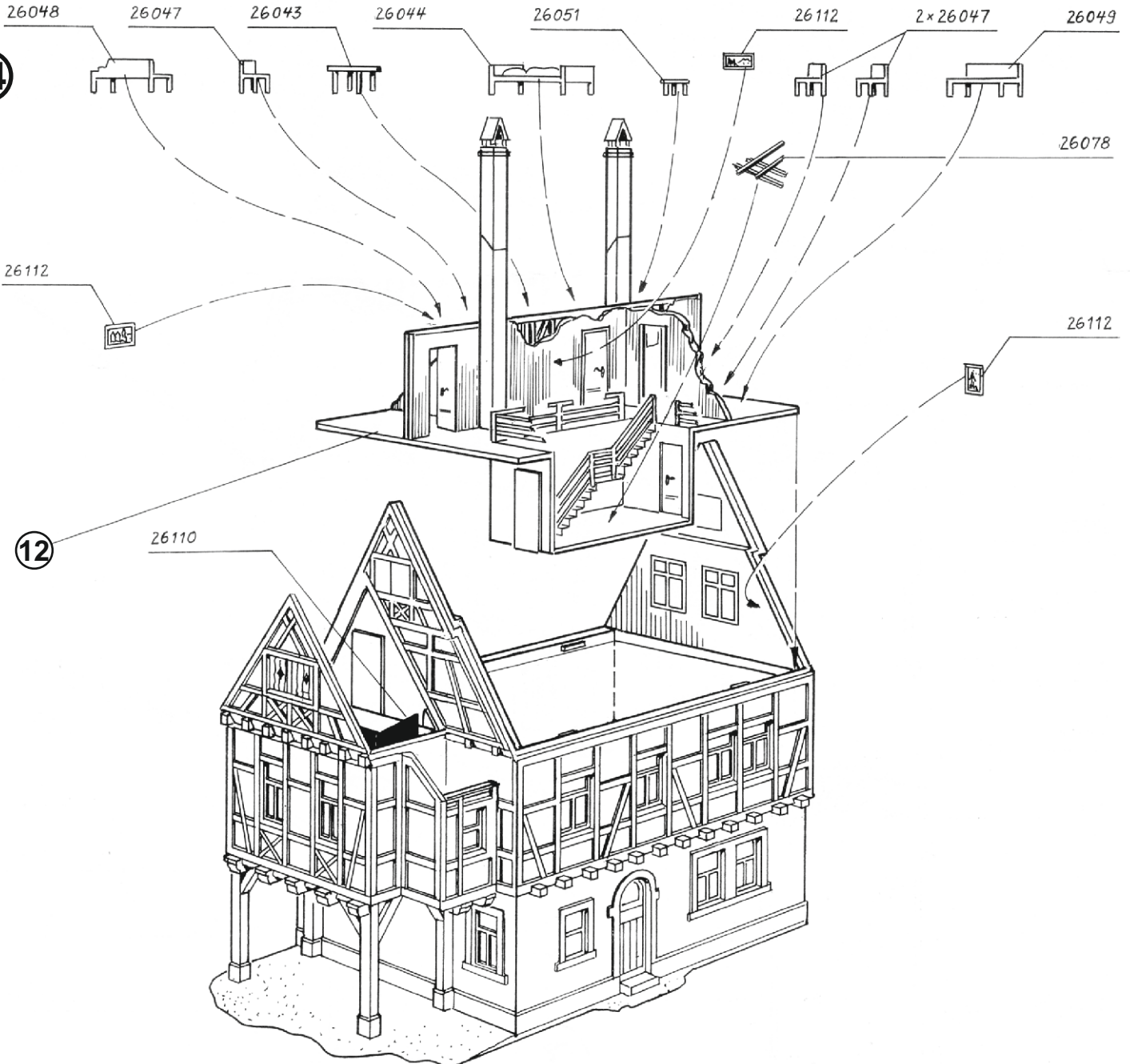

26054

15

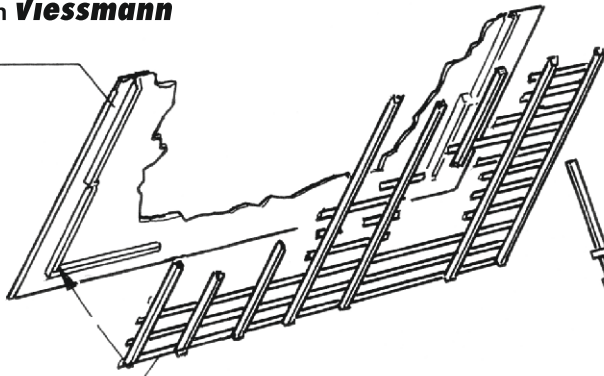

26075

26076

16

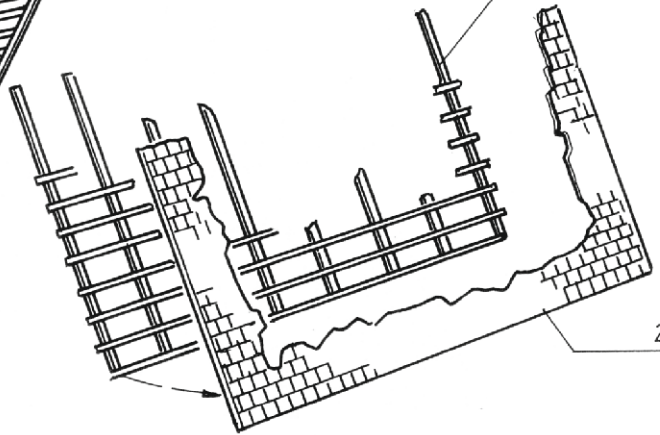

26055

17

11

23240

15

26071

16

26056

23270

26057

23556

23230

23229

23235

26110

23274

2 x 23236

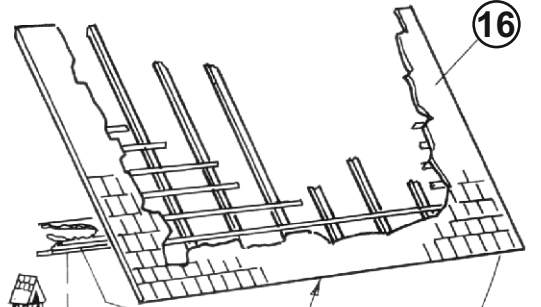
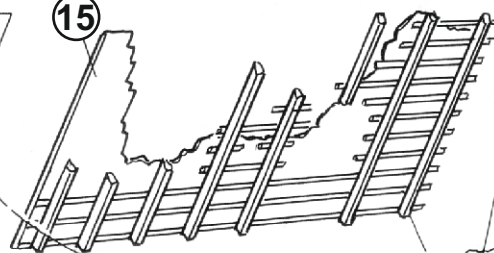

26072

26077

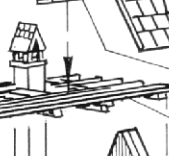
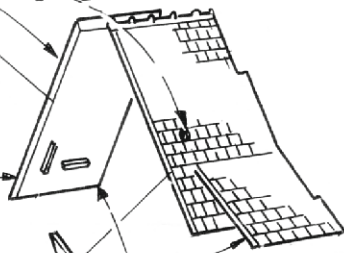

138653  
**Farbtablette**  
Colour tablet

23232

23233

23234

23237

23231